

Made in Italy



Moby P 1.0, code: MP10005LI
Projectors for underwater applications

21/11/2024 Rev. 38







 kg 1,35
 

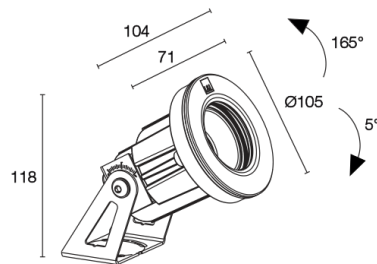

CASAMBI



DESCRIPTION

projector for underwater applications (not suitable for use in seawater, only suitable for underwater applications); surface mounted (wall, floor), max depth 10 m; Power consumption: 10W; Power supply: 24Vdc; Lumen output at source: 713 lm (3000K); Delivered lumen output: 506 lm (3000K, 21°); 1 power LEDs group, 2-step MacAdam, 50 000h L90 B10 (Ta 25°C); LED colour: 3000K; Optics: 59°: optical system consisting of a high-efficiency, deep-set TIR lens combined with a high-quality technical filter; CRI Colour Rendering Index: 80; Body material: body made of heat-dissipating technopolymer with a thermal conductivity equal to that of stainless steel. Trim in AISI 316L stainless steel, made on a CNC lathe then micro-peened, passivated and electropolished to guarantee excellent corrosion resistance. Bracket in AISI 316L stainless steel, tumble finished and painted; Finishes: stainless steel; Screen material: 12-mm-thick transparent extra-clear glass, tempered for excellent resistance to knocks and scratches. Mixing chamber to ensure the light's chromatic uniformity; power supply unit not included; includes 5 m neoprene cable, H05RN-F 2x1,00 Ø6.8 mm; Ingress protection: IP65, IP68; Impact resistance: IK10; Casambi control using the Casambi app with dedicated electronics; Protection systems: IPS (Intelligent Protection System) protects lighting fixtures from water infiltrations, which can occur if there are faulty junctions between the cables in outdoor or underwater applications. This innovation, patented by L&L, also guarantees electrical protection against polarity reversal, hot plugging, ESD and power surges, which can occur if there are faults in the electrical circuit; Operating temperature: 0°C — +45°C (installation underwater); Glow wire test: 960°; Photobiological safety: photobiological safety: risk group 1 according to EN 62471:2006; Appliance class: class III; Weight: 1350 g; Dimensions: Ø105x118 mm; Energy efficiency class: F (light source) in accordance with EU 2019/2015; Accessories: WH0401 Honeycomb louvre ; tested and approved via E.O.L. (End Of Line) test with functioning test and check of electrical power consumption

Status: Available

ELECTRICAL CHARACTERISTICS

Power consumption	10W
Power supply	24Vdc
Power supply unit	power supply unit not included

LIGHTING CHARACTERISTICS

Number and type of LED	1 power LEDs group
Average LED life	50 000h L90 B10 (Ta 25°C)
LED colour	3000K
CRI Colour Rendering Index	80
Binning	2-step MacAdam
Optics	59°
Lumen output at source	713 lm (3000K)
Delivered lumen output	506 lm (3000K, 21°)

MECHANICAL CHARACTERISTICS

Dimensions	Ø105x118 mm
Weight	1350 g
Finishes	stainless steel
Mounting	with screws and plugs
Body material	body in thermally conductive technopolymer, trim in AISI 316L stainless steel, bracket in AISI 316L stainless steel
Screen material	screen in tempered, transparent extra-clear glass

GENERAL CHARACTERISTICS

Ingress protection	IP65, IP68
Operating temperature	0°C — +45°C (installation underwater)
Impact resistance	IK10
Energy efficiency class	F (light source) in accordance with EU 2019/2015
Glow wire test	960°
Appliance class	class III
Walkover	no
Drive-over	no
Power cables	includes 5 m neoprene cable, H05RN-F 2x1,00 Ø6.8 mm
Protection systems	IPS (Intelligent Protection System)
Photobiological safety	photobiological safety: risk group 1 according to EN 62471:2006
Notes	Casambi control using the Casambi app with dedicated electronics

PHOTOMETRIC DATA

L – 59°

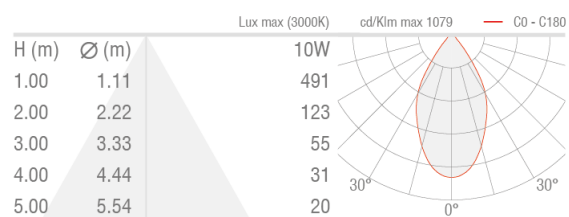

ACCESSORIES

Anti-glare

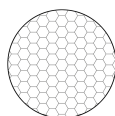

WH0401

Honeycomb louvre

built into the lighting fixture

Order together with the lighting fixture

L&L Luce&Light SRL reserves the right to change the information contained in this document at any time without prior notice being given.