









Made in Italy

 **Zab Track 3.0, code: ZT301019LN**
Projectors for indoor applications

17/07/2024 Rev. 30



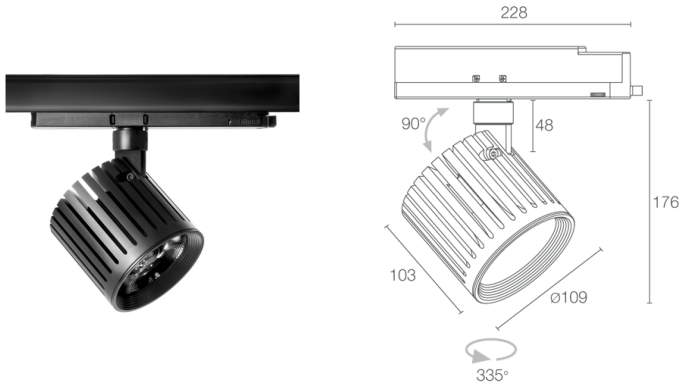

 kg 1,25
 



DESCRIPTION

projector for indoor applications; on horizontal track; Power consumption: 34W; Power supply: 230Vac; Lumen output at source: 2505 lm (3000K); Delivered lumen output: 1785 lm (3000K, 25°); 1 COB LED Xicato Xtm Artist Series®, 2-step MacAdam, 50 000h L90 B10 (Ta 25°C); LED colour: 4000K; Optics: 42°: optical system consisting of a high-efficiency TIR lens; CRI Colour Rendering Index: 98; Body material: body and screw ring made of extruded anodized aluminium, produced entirely on a CNC lathe; Finishes: body and ring anodized glossy black (RAL 9005); RAL finish on request; built-in power supply unit; Ingress protection: IP40; CRI 98 (R9>98); IES TM-30 Colour Fidelity (Rf) 96, Colour Gamut (Rg) 103, Casambi-compatible version, controllable with the Casambi app, available on request; Eurostandard adaptor; Operating temperature: 0°C – +45°C; Photobiological safety: photobiological safety: risk group 1 according to EN 62471:2006; Appliance class: class I; Weight: 1250 g; Dimensions: Ø109x105 mm; Energy efficiency class: F (light source) in accordance with EU 2019/2015; Accessories: BE0017001 Suspension kit with 2 m cable and clutch adjustment, BE0030011 Lighting track 3-CCT aluminium 1000 mm - black, BE0030021 Lighting track 3-CCT aluminium 2000 mm - black, BE0030031 Lighting track 3-CCT aluminium 3000 mm - black, BE0031001 Supply connector earth conductor on left - black, BE0031011 Supply connector earth conductor on right - black, BE0031101 Concealed coupling with wiring - black, BE0031201 End cap - black, BE0031301 L-shaped coupling ground external - black, BE0031311 L-shaped coupling ground internal - black, BE0031401 Flexible coupling - black, BE0032001 Cover - length 1000 mm - black, WB0404N Standard snoot - black, WB0405N Asymmetrical snoot - black, WB0406N Barn doors - black, WH0711 Honeycomb louvre ; tested and approved via E.O.L. (End Of Line) test with functioning test and check of electrical power consumption

Status: Product being discontinued

ELECTRICAL CHARACTERISTICS

Power consumption	34W
Power supply	230Vac
Power supply unit	built-in power supply unit

LIGHTING CHARACTERISTICS

Number and type of LED	1 COB LED Xicato Xtm Artist Series®
Average LED life	50 000h L90 B10 (Ta 25°C)
LED colour	4000K
CRI Colour Rendering Index	98
Binning	2-step MacAdam
Optics	42°
Lumen output at source	2505 lm (3000K)
Delivered lumen output	1785 lm (3000K, 25°)

MECHANICAL CHARACTERISTICS

Dimensions	Ø109x105 mm
Weight	1250 g
Finishes	black RAL 9005
Mounting	with Eurostandard adaptor
Body material	body in anodized aluminium

GENERAL CHARACTERISTICS

Ingress protection	IP40
Operating temperature	0°C — +45°C
Features	CRI 98 (R9>98)
Energy efficiency class	F (light source) in accordance with EU 2019/2015
Appliance class	class I
Walkover	no
Drive-over	no
Photobiological safety	photobiological safety: risk group 1 according to EN 62471:2006
Notes	IES TM-30 Colour Fidelity (Rf) 96, Colour Gamut (Rg) 103, Casambi-compatible version, controllable with the Casambi app, available on request; Eurostandard adaptor

PHOTOMETRIC DATA

L - 42°

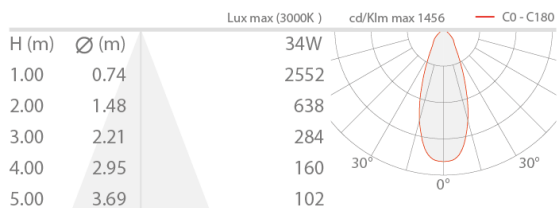

ACCESSORIES

Anti-glare



WB0404N
Standard snoot - black



WB0405N
Asymmetrical snoot - black



WB0406N
Barn doors - black

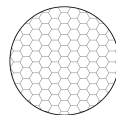

WH0711
Honeycomb louvre
built into the lighting fixture
Order together with the lighting fixture

Other

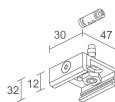

BE0017001
Suspension kit with 2 m cable and clutch adjustment

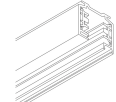

BE0030011
Lighting track 3-CCT aluminium 1000 mm - black

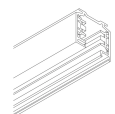

BE0030021
Lighting track 3-CCT aluminium 2000 mm - black

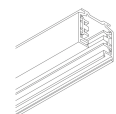

BE0030031
Lighting track 3-CCT aluminium 3000 mm - black

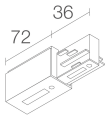

BE0031001

Supply connector earth conductor on left - black

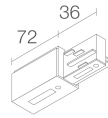

BE0031011

Supply connector earth conductor on right - black

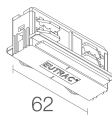

BE0031101

Concealed coupling with wiring - black

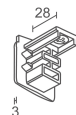

BE0031201

End cap - black

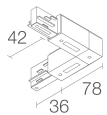

BE0031301

L-shaped coupling ground external - black

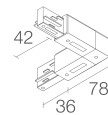

BE0031311

L-shaped coupling ground internal - black

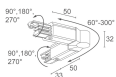

BE0031401

Flexible coupling - black

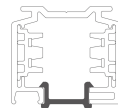

BE0032001

Cover - length 1000 mm - black

L&L Luce&Light SRL reserves the right to change the information contained in this document at any time without prior notice being given.