













Made in Italy

 **Rondò 3.2, code: RD32105AI**  
Step lights for outdoor applications

30/06/2024 Rev. 34

**CASAMBI**  

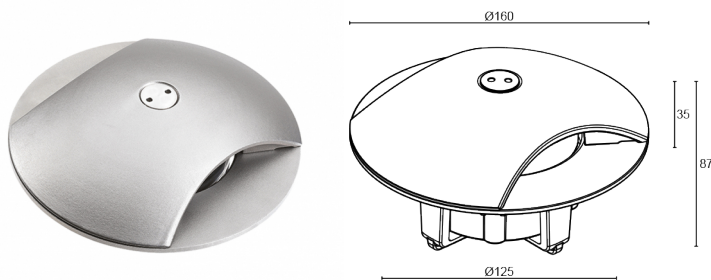

## DESCRIPTION

step light for outdoor applications, double beam; drive-over up to 5000 kg; recessed (floor); Power consumption: 5W; Power supply: 230Vac; Lumen output at source: 370 lm (3000K); Delivered lumen output: 180 lm (3000K, radial optics); 2 power LEDs, 1/4 ANSI BIN, 50 000h L95 B10 (Ta 25°C); LED colour: 3000K; Optics: radial: optical system consisting of a high-efficiency TIR lens; Upward flux fraction: 38,18% (radial optics), 21,13% (10°); CRI Colour Rendering Index: 80; Body material: body made of micro-cast AISI 316L stainless steel, produced entirely on a CNC lathe; Finishes: stainless steel finish obtained through micro-shot peening, an electrolytic passivation treatment and electropolishing; RAL finish on request; Screen material: Rilsan® Clear protective screen in clear PA12 polyamide with high mechanical and optical performance; Seals: O-ring in 4-mm expanded silicone; built-in power supply unit; includes 1.5 m neoprene cable H07RN-F 3x1,0 Ø8,7 mm; Ingress protection: IP67; Impact resistance: IK08; Casambi control using the Casambi app with dedicated electronics; Protection systems: IPS (Intelligent Protection System) protects lighting fixtures from water infiltrations, which can occur if there are faulty junctions between the cables in outdoor or underwater applications. This innovation, patented by L&L, also guarantees electrical protection against polarity reversal, hot plugging, ESD and power surges, which can occur if there are faults in the electrical circuit; The PID (Protective Impedance Device) protects lighting fixtures from electrical phenomena external to the system, such as static electricity accumulation or electromagnetic interference coming from the mains power. Generally, these are events with a low energy content; Operating temperature: -20°C — +45°C; Maximum device temperature: 45°C (Ta 25°C); Photobiological safety: photobiological safety: risk group 1 according to EN 62471:2006; Appliance class: class I; Weight: 1800 g; Dimensions: Ø160x87 mm; Energy efficiency class: F (light source) in accordance with EU 2019/2015; Accessories: WC0601 Outer casing, WC0701 Outer casing, WE0100 Tool for tamper-resistant screws; tested and approved via E.O.L. (End Of Line) test with functioning test and check of electrical power consumption

Status: Available

### ELECTRICAL CHARACTERISTICS

Power consumption	5W
Power supply	230Vac
Power supply unit	built-in power supply unit

### LIGHTING CHARACTERISTICS

Number and type of LED	2 power LEDs
Average LED life	50 000h L95 B10 (Ta 25°C)
LED colour	3000K
CRI Colour Rendering Index	80
Binning	1/4 ANSI BIN
Optics	radial
Lumen output at source	370 lm (3000K)
Delivered lumen output	180 lm (3000K, radial optics)

### MECHANICAL CHARACTERISTICS

Dimensions	Ø160x87 mm
Weight	1800 g
Finishes	stainless steel
Mounting	with outer casing
Body material	body in AISI 316L stainless steel
Screen material	screen in Rilsan® Clear

### GENERAL CHARACTERISTICS

Operating temperature	-20°C — +45°C
Ingress protection	IP67
Impact resistance	IK08
Energy efficiency class	F (light source) in accordance with EU 2019/2015
Maximum device temperature	45°C (Ta 25°C)
Appliance class	class I
Walkover	yes
Drive-over	up to 5000 kg
Power cables	includes 1.5 m neoprene cable H07RN-F 3x1,0 Ø8,7 mm
Protection systems	IPS (Intelligent Protection System); PID (Protective Impedance Device)
Photobiological safety	photobiological safety: risk group 1 according to EN 62471:2006
Notes	Casambi control using the Casambi app with dedicated electronics

## PHOTOMETRIC DATA

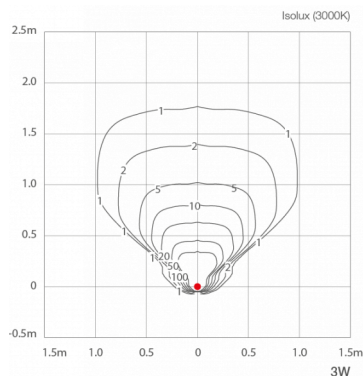

## ACCESSORIES

### Installation Accessories



WC0601  
Outer casing



WC0701  
Outer casing

### Other



WE0100  
Tool for tamper-resistant screws

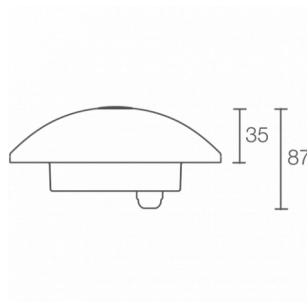

L&L Luce&Light SRL reserves the right to change the information contained in this document at any time without prior notice being given.