











Made in Italy

 **Rondò 2.1, code: RD21005AH-1**
Step lights for outdoor applications



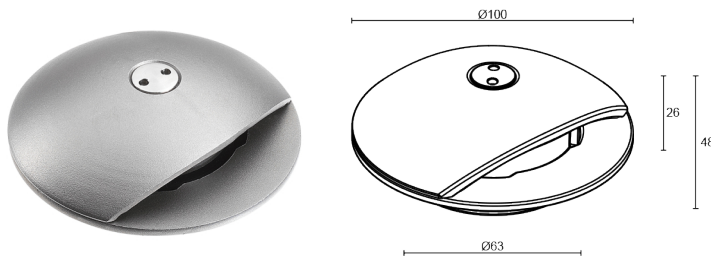

 kg 5000 - kN 50
  kg 0,73
 IP67 IK08
 

 T max 45°C
  A+ G F



DESCRIPTION

step light for outdoor applications, single beam; drive-over up to 5000 kg; recessed (floor); Power consumption: 2W; Power supply: 24Vdc; Lumen output at source: 185 lm (3000K); Delivered lumen output: 85 lm (3000K, radial optics); 1 power LED, 1/4 ANSI BIN, 50 000h L95 B10 (Ta 25°C); LED colour: 3000K; Optics: radial: optical system consisting of a high-efficiency TIR lens; Upward flux fraction: 46,15% (radial optics), 30,61% (10°); CRI Colour Rendering Index: 80; Body material: body made of micro-cast AISI 316L stainless steel, produced entirely on a CNC lathe; Finishes: anthracite finish obtained through micro-shot peening, an electrolytic passivation treatment and electropolishing; then painted through an initial treatment with a ceramic nanoparticle coating, to prepare for painting, followed by a coat of epoxy paint and one of polyester paint, to provide corrosion resistance of more than 1000 hours of salt spray testing. Paints compliant with the Qualicoat standard used in the automotive sector; RAL finish on request; Screen material: Rilsan® Clear protective screen in clear PA12 polyamide with high mechanical and optical performance; Seals: O-ring in 4-mm expanded silicone; power supply unit not included; includes 5 m neoprene cable, H05RN-F 2x0,35/0,75 Ø6,3 mm; Ingress protection: IP67; Impact resistance: IK08; Casambi control using the Casambi app with dedicated electronics; Protection systems: IPS (Intelligent Protection System) protects lighting fixtures from water infiltrations, which can occur if there are faulty junctions between the cables in outdoor or underwater applications. This innovation, patented by L&L, also guarantees electrical protection against polarity reversal, hot plugging, ESD and power surges, which can occur if there are faults in the electrical circuit; Operating temperature: -20°C — +45°C; Maximum device temperature: 45°C (Ta 25°C); Photobiological safety: photobiological safety: risk group 1 according to EN 62471:2006; Appliance class: class III; Weight: 730 g; Dimensions: Ø100x48 mm; Energy efficiency class: F (light source) in accordance with EU 2019/2015; Accessories: WC0100 Outer casing, WC0103 Outer casing, WC0150 Outer casing, WE0100 Tool for tamper-resistant screws; tested and approved via E.O.L. (End Of Line) test with functioning test and check of electrical power consumption

Status: Available

ELECTRICAL CHARACTERISTICS

Power consumption	2W
Power supply	24Vdc
Power supply unit	power supply unit not included

LIGHTING CHARACTERISTICS

Number and type of LED	1 power LED
Average LED life	50 000h L95 B10 (Ta 25°C)
LED colour	3000K
CRI Colour Rendering Index	80
Binning	1/4 ANSI BIN
Optics	radial
Lumen output at source	185 lm (3000K)
Delivered lumen output	85 lm (3000K, radial optics)

MECHANICAL CHARACTERISTICS

Dimensions	Ø100x48 mm
Weight	730 g
Finishes	anthracite
Mounting	with outer casing
Body material	body in AISI 316L stainless steel
Screen material	screen in Rilsan® Clear

GENERAL CHARACTERISTICS

Ingress protection	IP67
Operating temperature	-20°C — +45°C
Impact resistance	IK08
Energy efficiency class	F (light source) in accordance with EU 2019/2015
Maximum device temperature	45°C (Ta 25°C)
Appliance class	class III
Walkover	yes
Drive-over	up to 5000 kg
Power cables	includes 5 m neoprene cable, H05RN-F 2x0,35/0,75 Ø6,3 mm
Protection systems	IPS (Intelligent Protection System)
Photobiological safety	photobiological safety: risk group 1 according to EN 62471:2006
Notes	Casambi control using the Casambi app with dedicated electronics

PHOTOMETRIC DATA

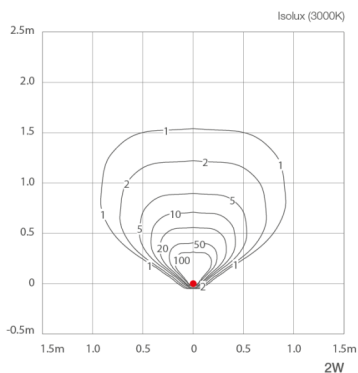

ACCESSORIES

Installation Accessories



WC0100
Outer casing

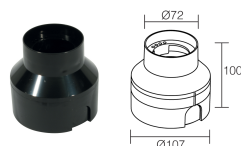

WC0103
Outer casing



WC0150
Outer casing

Other



WE0100
Tool for tamper-resistant screws



L&L Luce&Light SRL reserves the right to change the information contained in this document at any time without prior notice being given.