











Made in Italy

 Reiko 2.0, code: RK2002000050L5
Projectors for outdoor applications

30/01/2025 Rev. 02/2024





 kg 0,500
 

 F

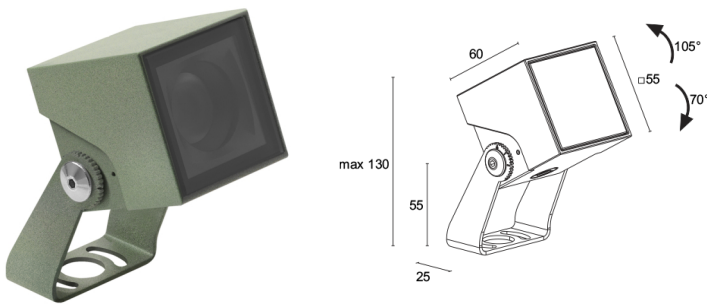

DESCRIPTION

projector for outdoor applications; surface mounted (ceiling, wall, ground, spike); Power consumption: 7W; Power supply: 24Vdc; Lumen output at source: 657 lm (3000K, 7W, CRI 80); Delivered lumen output: 407 lm (3000K, 18°, 7W, CRI 80); 1 power LED, 3-step MacAdam, 60 000h L90 B10 (Ta 25°C); LED colour: 3000K; Optics: 44°: optical system consisting of a high-efficiency TIR lens; CRI Colour Rendering Index: 80; Body material: body made of low-copper-content die-cast aluminium alloy EN AB 47100 for excellent resistance to corrosion. Bracket in AISI 316L stainless steel, tumble finished and painted; Finishes: jasper green finish obtained through an initial treatment with a ceramic nanoparticle coating, to prepare for painting, followed by a coat of epoxy paint and one of polyester paint to provide corrosion resistance of more than 1500 hours of salt spray. Paints compliant with the Qualicoat standard used in the automotive sector; RAL finish on request; Screen material: 4-mm-thick transparent extra-clear glass, with high transmittance to ensure chromatic uniformity of light and tempered for excellent resistance to knocks and scratches, with RAL 7015 grey vitrified serigraphy around the edge; power supply unit not included; includes 1.50 m neoprene cable H05RN-F 2x0.75/0.75 Ø6.3 mm; Ingress protection: IP66; Impact resistance: IK06; Casambi control using the Casambi app with dedicated electronics; Protection systems: IPS (Intelligent Protection System) protects lighting fixtures from water infiltrations, which can occur if there are faulty junctions between the cables in outdoor or underwater applications. This innovation, patented by L&L, also guarantees electrical protection against polarity reversal, hot plugging, ESD and power surges, which can occur if there are faults in the electrical circuit; The PID (Protective Impedance Device) protects lighting fixtures from electrical phenomena external to the system, such as static electricity accumulation or electromagnetic interference coming from the mains power. Generally, these are events with a low energy content; Operating temperature: -20°C — +50°C; Glow wire test: 960°C; Photobiological safety: in accordance with IEC TR 62778:2014; Appliance class: class III; Weight: 500 g; Dimensions: 55x55x60 mm; Energy efficiency class: F (light source) in accordance with EU 2019/2015; Accessories: WBA105 Standard square snoot - jasper green, WBA115 Asymmetrical square snoot - jasper green, WF3301 Flexible cable-protection tube - 15 cm, WP0100 Spike for in-ground installation, WP1004 Fastener strap - 5 m, WP10065 Spike for in-ground installation - h 500 mm - jasper green, WP10075 Spike for in-ground installation - h 800 mm - jasper green; tested and approved via E.O.L. (End Of Line) test with functioning test and check of electrical power consumption

Status: Available

ELECTRICAL CHARACTERISTICS

Power consumption	7W
Power supply	24Vdc
Power supply unit	power supply unit not included

LIGHTING CHARACTERISTICS

Number and type of LED	1 power LED
Average LED life	60 000h L90 B10 (Ta 25°C)
LED colour	3000K
CRI Colour Rendering Index	80
Binning	3-step MacAdam
Optics	44°
Lumen output at source	657 lm (3000K, 7W, CRI 80)
Delivered lumen output	407 lm (3000K, 18°, 7W, CRI 80)

MECHANICAL CHARACTERISTICS

Dimensions	55x55x60 mm
Weight	500 g
Finishes	jasper green
Mounting	with bracket, screws and plugs
Body material	body in die-cast aluminium, AISI 316L stainless steel bracket
Screen material	screen in serigraphed-grey and transparent, tempered extra-clear glass

GENERAL CHARACTERISTICS

Ingress protection	IP66
Operating temperature	-20°C — +50°C
Impact resistance	IK06
Energy efficiency class	F (light source) in accordance with EU 2019/2015
Glow wire test	960°C
Appliance class	class III
Walkover	no
Drive-over	no
Power cables	includes 1.50 m neoprene cable H05RN-F 2x0.75/0.75 Ø6.3 mm
Protection systems	IPS (Intelligent Protection System); PID (Protective Impedance Device)
Photobiological safety	in accordance with IEC TR 62778:2014
Notes	Casambi control using the Casambi app with dedicated electronics

PHOTOMETRIC DATA

L – 44° CRI80

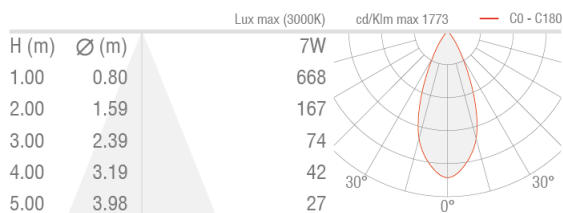

ACCESSORIES

Installation Accessories

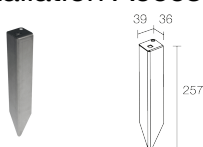

WP0100
Spike for in-ground installation

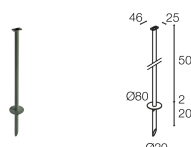

WP10065
Spike for in-ground installation - h 500 mm - jasper green

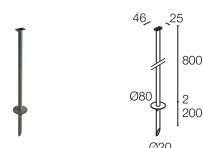

WP10075
Spike for in-ground installation - h 800 mm - jasper green

Anti-glare

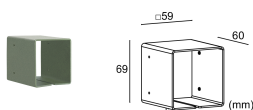

WBA105
Standard square snout - jasper green

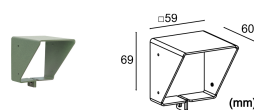

WBA115
Asymmetrical square snout - jasper green

Other



WF3301



WP1004

Flexible cable-protection tube - 15 cm
Order together with the lighting fixture

Fastener strap - 5 m

L&L Luce&Light SRL reserves the right to change the information contained in this document at any time without prior notice being given.