











Made in Italy

 **Snack 2.1, code: SK2100FWA**
Linear profiles for indoor applications

31/03/2025 Rev. 08/2024



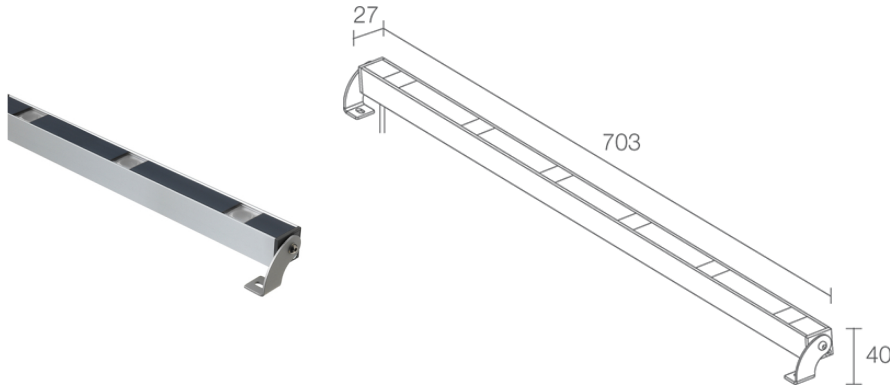

 kg 0,57
 





DESCRIPTION

linear profile for indoor applications; surface mounted (ceiling, wall, floor); Power consumption: 11W; Power supply: 24Vdc; Lumen output at source: 835 lm (3000K); Delivered lumen output: 510 lm (3000K, 30°); 6 power LEDs, 2-step MacAdam, 50 000h L90 B10 (Ta 25°C); LED colour: 2700K; Optics: 10°x45°; CRI Colour Rendering Index: 80; Body material: body in anodized aluminium; Finishes: anodized grey; RAL finish on request; Screen material: screen in serigraphed transparent polycarbonate; power supply unit not included; includes 1.5 m PVC cable FROR 2x0.35 Ø3.5 mm; Ingress protection: IP40; non-standard lengths available on request; Casambi control using the Casambi app with dedicated electronics; Protection systems: This is an NTC thermistor mounted on the LED board to protect the lighting fixture against overheating. Should the product function at an operating temperature greater than the maximum temperature at which it can operate correctly, the protection is activated and gradually reduces the power. The NTC causes the integrated electronic parts to cool down to avoid the lighting fixture instantly switching itself off. When the operating temperature is again within normal range, the NTC automatically restores the lighting fixture's original operating conditions; Operating temperature: 0°C — +45°C; Glow wire test: 730°C; Photobiological safety: photobiological safety: risk group 1 according to EN 62471:2006; Appliance class: class III; Weight: 570 g; Dimensions: 703x40x27 mm; Energy efficiency class: F (light source) in accordance with EU 2019/2015; tested and approved via E.O.L. (End Of Line) test with functioning test and check of electrical power consumption

Status: Product being discontinued

ELECTRICAL CHARACTERISTICS

Power consumption	11W
Power supply	24Vdc
Power supply unit	power supply unit not included

LIGHTING CHARACTERISTICS

Number and type of LED	6 power LEDs
Average LED life	50 000h L90 B10 (Ta 25°C)
LED colour	2700K
CRI Colour Rendering Index	80
Binning	2-step MacAdam
Optics	10°x45°
Lumen output at source	835 lm (3000K)
Delivered lumen output	510 lm (3000K, 30°)

MECHANICAL CHARACTERISTICS

Dimensions	703x40x27 mm
Weight	570 g
Finishes	anodized grey
Mounting	with adjustable brackets and screws
Body material	body in anodized aluminium
Screen material	screen in serigraphed transparent polycarbonate

GENERAL CHARACTERISTICS

Ingress protection	IP40
Operating temperature	0°C — +45°C
Energy efficiency class	F (light source) in accordance with EU 2019/2015
Glow wire test	730°C
Appliance class	class III
Walkover	no
Drive-over	no
Power cables	includes 1.5 m PVC cable FROR 2x0.35 Ø3.5 m
Protection systems	NTC (thermistor mounted on LED board)
Photobiological safety	photobiological safety: risk group 1 according to EN 62471:2006
Notes	non-standard lengths available on request; Casambi control using the Casambi app with dedicated electronics

PHOTOMETRIC DATA

W – 10°x45°

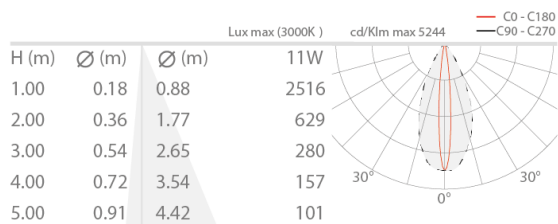

L&L Luce&Light SRL reserves the right to change the information contained in this document at any time without prior notice being given.