











Made in Italy

 **Geko 5.0, code: GK50105DE**
Wall mounted for outdoor applications

04/12/2024 Rev. 38



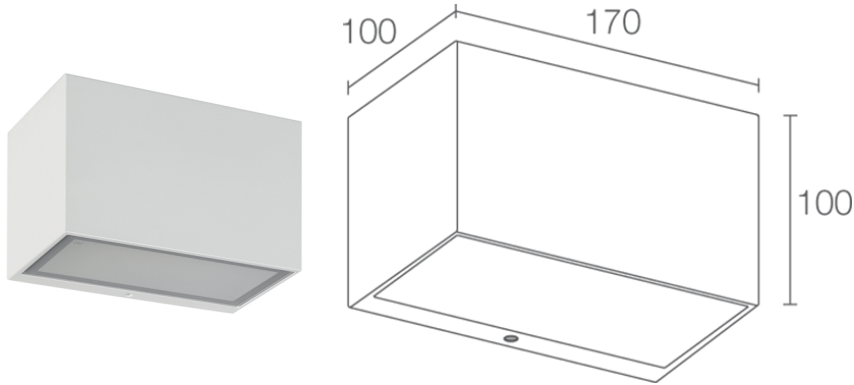

 kg 1,80
 





DESCRIPTION

wall mounted for outdoor applications, single beam; surface mounted (wall); Power consumption: 10W; Power supply: 230Vac; Lumen output at source: 713 lm (3000K, 10W); Delivered lumen output: 531 lm (3000K, 10W); power LED matrix, 3-step MacAdam, 50 000h L80 B10 (Ta 25°C); LED colour: 3000K; Optics: diffuse; CRI Colour Rendering Index: 80; Body material: body in die-cast aluminium; Finishes: white (RAL 9003); RAL finish on request; Screen material: screen in serigraphed, sandblasted, tempered extra-clear glass; built-in power supply unit; connection box with 0.30 m cable; Ingress protection: IP65; Impact resistance: IK07; spacer with RAL finish available on request, Casambi-compatible version, controllable with the Casambi app, available on request; Operating temperature: -20°C — +45°C; Glow wire test: 960°; Photobiological safety: photobiological safety: risk group 1 according to EN 62471:2006; Appliance class: class I; Weight: 1800 g; Dimensions: 170x100x100 mm; Energy efficiency class: F (light source) in accordance with EU 2019/2015; Accessories: WD0300E Spacer - white; tested and approved via E.O.L. (End Of Line) test with functioning test and check of electrical power consumption

Status: Available

ELECTRICAL CHARACTERISTICS

Power consumption	10W
Power supply	230Vac
Power supply unit	built-in power supply unit

LIGHTING CHARACTERISTICS

Number and type of LED	power LED matrix
Average LED life	50 000h L80 B10 (Ta 25°C)
LED colour	3000K
CRI Colour Rendering Index	80
Binning	3-step MacAdam
Optics	diffuse
Lumen output at source	713 lm (3000K, 10W)
Delivered lumen output	531 lm (3000K, 10W)

MECHANICAL CHARACTERISTICS

Dimensions	170x100x100 mm
Weight	1800 g
Finishes	white RAL 9003
Mounting	with mounting plate, screws and plugs
Body material	body in die-cast aluminium
Screen material	screen in serigraphed, sandblasted, tempered extra-clear glass

GENERAL CHARACTERISTICS

Ingress protection	IP65
Operating temperature	-20°C — +45°C
Impact resistance	IK07
Energy efficiency class	F (light source) in accordance with EU 2019/2015
Glow wire test	960°
Appliance class	class I
Walkover	no
Drive-over	no
Power cables	connection box with 0.30 m cable
Photobiological safety	photobiological safety: risk group 1 according to EN 62471:2006
Notes	spacer with RAL finish available on request, Casambi-compatible version, controllable with the Casambi app, available on request

PHOTOMETRIC DATA

D – Diffuse

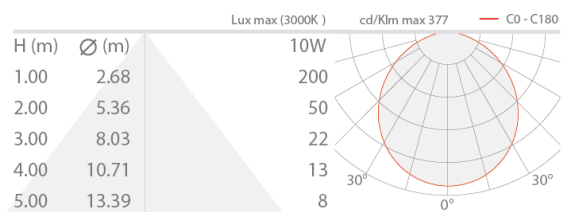

ACCESSORIES

Installation Accessories

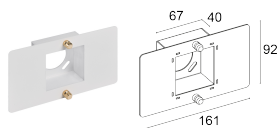

WD0300E

Spacer - white

L&L Luce&Light SRL reserves the right to change the information contained in this document at any time without prior notice being given.