

Made in Italy

 **Krill 3.0, code: KI3020100050KN**  
Projectors for indoor applications

18/07/2024 Rev. 29

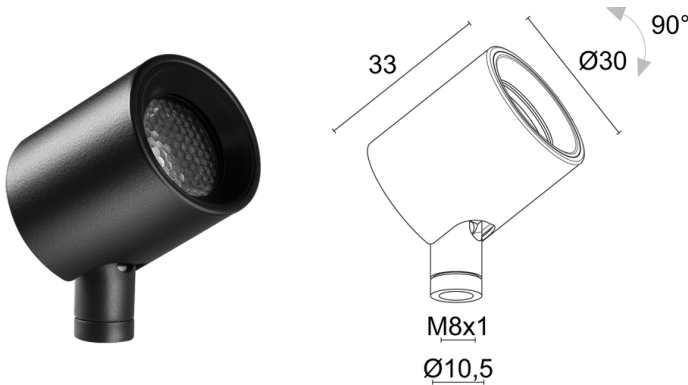
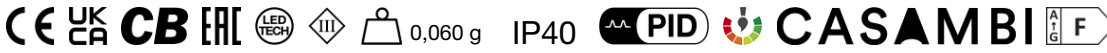

## DESCRIPTION

projector for indoor applications; surface mounted (shop windows, display cabinets, shelves, ceiling, wall); Power consumption: max 4,5W; Power supply: max 350mA; Lumen output at source: 452 lm (3000K, 350mA); Delivered lumen output: 281 lm (3000K, 350mA, 23°); 1 power LED High Intensity, 3-step MacAdam, 50 000h L90 B10 (Ta 25°C); LED colour: 3000K; Optics: 42°: optical system consisting of a high-efficiency TIR lens; CRI Colour Rendering Index: >90; Body material: body made of ANTICORODAL EN AW 6026 low-copper-content aluminium alloy for excellent resistance to corrosion, made entirely on a CNC lathe. Joint made of brass and produced entirely on a CNC lathe.; Finishes: cylindrical cover and joint painted black, body electro-coloured black (RAL 9005); RAL finish on request; Installation: versatile installation thanks to its accessories: arm with fixing base, nipple coupler, magnetic plate, fixing springs and ceiling rose; power supply unit not included; Wiring: series; includes 1.50 m PVC cable HT105° 2x0.20 Ø3.0 mm; Control system: dimming via dimmable driver; Ingress protection: IP40; The cylindrical cover can be removed and replaced with the standard snoot. To attach the honeycomb louvre, remove the cylindrical cover, screw on the anti-glare accessory and replace the cover; Casambi control using the Casambi app with dedicated electronics; Protection systems: The PID (Protective Impedance Device) protects lighting fixtures from electrical phenomena external to the system, such as static electricity accumulation or electromagnetic interference coming from the mains power. Generally, these are events with a low energy content; Operating temperature: 0°C — +45°C; Photobiological safety: photobiological safety: risk group 1 according to EN 62471:2006; Appliance class: class III; Weight: 60 g; Dimensions: ø30x33 mm; Energy efficiency class: F (light source) in accordance with EU 2019/2015; Accessories: WBA01N Standard snoot - black, WDA00N Fixing base, WDA01N Rigid arm - h 150 mm, WDA02N Rigid arm - h 300 mm, WDA03N Ceiling rose, WDA04N Magnetic plate, WF0600 PVC cable HT105° 2x0,20 Ø3,0 mm, grey, WGA01 Nipple coupler, WGA08N Retaining spring clip Ø30mm, WHKI30A0 Honeycomb louvre; tested and approved via E.O.L. (End Of Line) test with functioning test and check of electrical power consumption

Status: Available

### ELECTRICAL CHARACTERISTICS

Power consumption	max 4,5W
Power supply	max 350mA
Power supply unit	power supply unit not included
Control system	dimming via dimmable driver
Wiring	series

### LIGHTING CHARACTERISTICS

Number and type of LED	1 power LED High Intensity
Average LED life	50 000h L90 B10 (Ta 25°C)
LED colour	3000K
CRI Colour Rendering Index	>90
Binning	3-step MacAdam
Optics	42°
Lumen output at source	452 lm (3000K, 350mA)
Delivered lumen output	281 lm (3000K, 350mA, 23°)

### MECHANICAL CHARACTERISTICS

Dimensions	ø30x33 mm
Weight	60 g
Finishes	black RAL 9005
Body material	body in anticorrosive aluminium, joint in brass

### GENERAL CHARACTERISTICS

Ingress protection	IP40
Operating temperature	0°C — +45°C
Energy efficiency class	F (light source) in accordance with EU 2019/2015
Appliance class	class III
Walkover	no
Drive-over	no
Power cables	includes 1.50 m PVC cable HT105° 2x0.20 Ø3.0 mm
Protection systems	PID (Protective Impedance Device)
Photobiological safety	photobiological safety: risk group 1 according to EN 62471:2006
Notes	The cylindrical cover can be removed and replaced with the standard snoot. To attach the honeycomb louvre, remove the cylindrical cover, screw on the anti-glare accessory and replace the cover; Casambi control using the Casambi app with dedicated electronics

## PHOTOMETRIC DATA

K - 42°

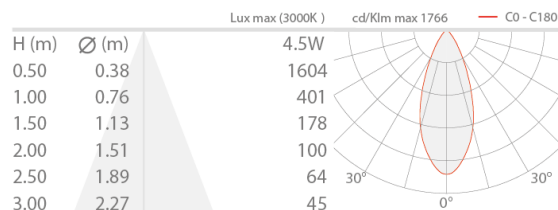

## ACCESSORIES

### Installation Accessories

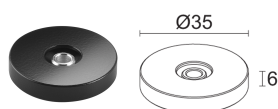

#### WDA00N

Fixing base  
black

Required installation accessories, not included

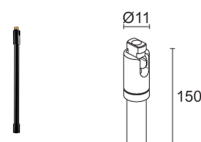

#### WDA01N

Rigid arm - h 150 mm  
black

Order together with the fixing base or the nipple

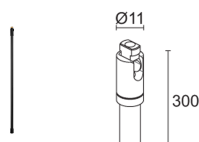

#### WDA02N

Rigid arm - h 300 mm  
black

Order together with the fixing base or the nipple

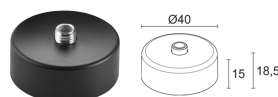

#### WDA03N

Ceiling rose  
black

Required installation accessories, not included

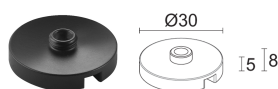

#### WDA04N

Magnetic plate  
black

Required installation accessories, not included

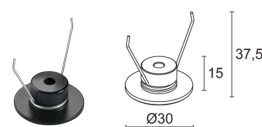

#### WGA08N

Retaining spring clip Ø30mm  
black

Required installation accessories, not included

### Anti-glare

**WBA01N**

Standard snout - black

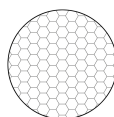
**WHKI30A0**

Honeycomb louvre

**Other****WF0600**

PVC cable HT105° 2x0,20 Ø3,0 mm, grey

your choice of length

Order together with the lighting fixture

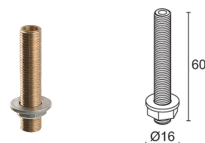
**WGA01**

Nipple coupler

Required installation accessories, not included

L&amp;L Luce&amp;Light SRL reserves the right to change the information contained in this document at any time without prior notice being given.