











Made in Italy

 **Krill 2.4, code: KI242010005R1Y**
Projectors for indoor applications

01/07/2024 Rev. 30



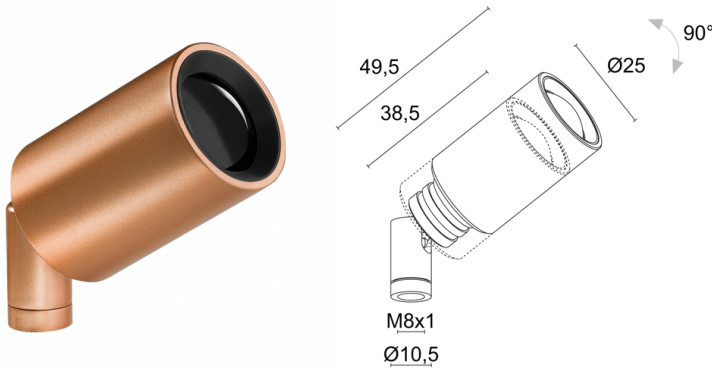



 0,065 g
 





DESCRIPTION

projector for indoor applications; surface mounted (shop windows, display cabinets, shelves, ceiling, wall); Power consumption: max 2,5W; Power supply: max 700mA; Lumen output at source: 202 lm (3000K, 700mA); Delivered lumen output: 176 lm (3000K, 700mA, 70°); 1 power LED, 1/4 ANSI BIN, 50 000h L90 B10 (Ta 25°C); LED colour: 3000K; Optics: optical range 9°—70°: optical system consisting of a plano-convex lens combined with a high-quality technical filter. The diameter of the light emission can be adjusted manually, ensuring maximum lighting flexibility; CRI Colour Rendering Index: >90; Body material: body made of ANTICORODAL EN AW 6026 low-copper-content aluminium alloy for excellent resistance to corrosion, made entirely on a CNC lathe. Joint made of brass and produced entirely on a CNC lathe.; Finishes: cylindrical cover and joint painted rose gold, radiator electro-coloured black; RAL finish on request; Installation: versatile installation thanks to its accessories: arm with fixing base, nipple coupler, magnetic plate, fixing springs and ceiling rose; power supply unit not included; Wiring: series; includes 1.50 m PVC cable HT105° 2x0.20 Ø3.0 mm; Control system: dimming via dimmable driver; Ingress protection: IP40; Casambi control using the Casambi app with dedicated electronics; Operating temperature: 0°C — +45°C; Photobiological safety: photobiological safety: risk group 1 according to EN 62471:2006; Appliance class: class III; Weight: 65 g; Dimensions: ø25x49,5 mm; Energy efficiency class: F (light source) in accordance with EU 2019/2015; Accessories: WDA00Y Fixing base, WDA01Y Rigid arm - h 150 mm, WDA02Y Rigid arm - h 300 mm, WDA03Y Ceiling rose, WDA04Y Magnetic plate, WF0600 PVC cable HT105° 2x0,20 Ø3,0 mm, grey, WGA01 Nipple coupler, WGA08Y Retaining spring clip Ø30mm; tested and approved via E.O.L. (End Of Line) test with functioning test and check of electrical power consumption

Status: Available

ELECTRICAL CHARACTERISTICS

Power consumption	max 2,5W
Power supply	max 700mA
Power supply unit	power supply unit not included
Control system	dimming via dimmable driver
Wiring	series

LIGHTING CHARACTERISTICS

Number and type of LED	1 power LED
Average LED life	50 000h L90 B10 (Ta 25°C)
LED colour	3000K
CRI Colour Rendering Index	>90
Binning	1/4 ANSI BIN
Optics	optical range 9° – 70°
Lumen output at source	202 lm (3000K, 700mA)
Delivered lumen output	176 lm (3000K, 700mA, 70°)

MECHANICAL CHARACTERISTICS

Dimensions	ø25x49,5 mm
Weight	65 g
Finishes	rose gold
Body material	body in anticorodal aluminium, joint in brass

GENERAL CHARACTERISTICS

Operating temperature	0°C – +45°C
Ingress protection	IP40
Energy efficiency class	F (light source) in accordance with EU 2019/2015
Appliance class	class III
Walkover	no
Drive-over	no
Power cables	includes 1.50 m PVC cable HT105° 2x0.20 Ø3.0 mm
Photobiological safety	photobiological safety: risk group 1 according to EN 62471:2006
Notes	Casambi control using the Casambi app with dedicated electronics

PHOTOMETRIC DATA

R1 zoom – 9° (9° - 70°)

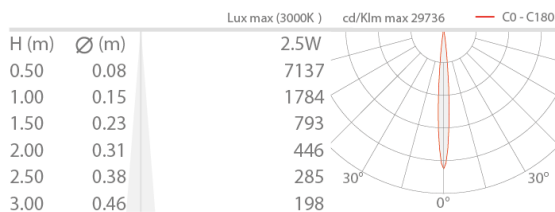

R1 zoom – 70° (9° - 70°)

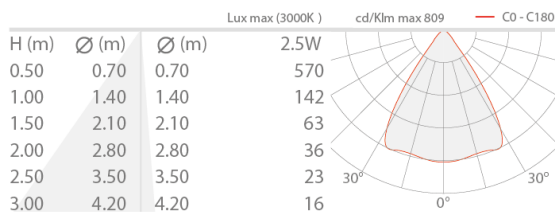

ACCESSORIES

Installation Accessories

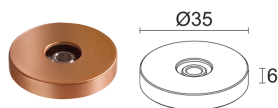

WDA00Y

Fixing base

rose gold

Required installation accessories, not included

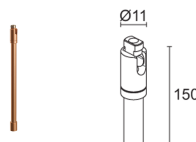

WDA01Y

Rigid arm - h 150 mm

rose gold

Order together with the fixing base or the nipple

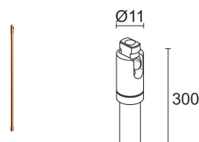

WDA02Y

Rigid arm - h 300 mm

rose gold

Order together with the fixing base or the nipple

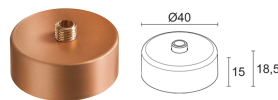

WDA03Y

Ceiling rose

rose gold

Required installation accessories, not included

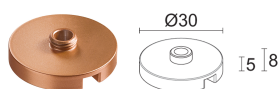

WDA04Y

Magnetic plate

rose gold

Required installation accessories, not included

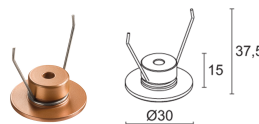

WGA08Y

Retaining spring clip Ø30mm

rose gold

Required installation accessories, not included

Other

WF0600

PVC cable HT105° 2x0,20 Ø3,0 mm, grey

your choice of length

Order together with the lighting fixture

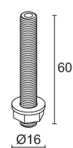
**WGA01**

Nipple coupler

Required installation accessories, not included

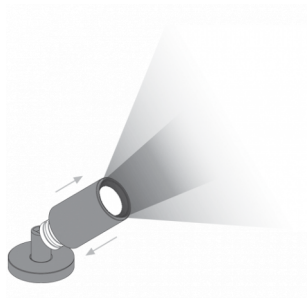

L&L Luce&Light SRL reserves the right to change the information contained in this document at any time without prior notice being given.