

Made in Italy

 **Combina D 3.0, code: CC3020100090L0**
Recessed for indoor applications

17/07/2024 Rev. 44





 0,90 kg
  IP40
  IP44 with filter
  **CASAMBI**
 F

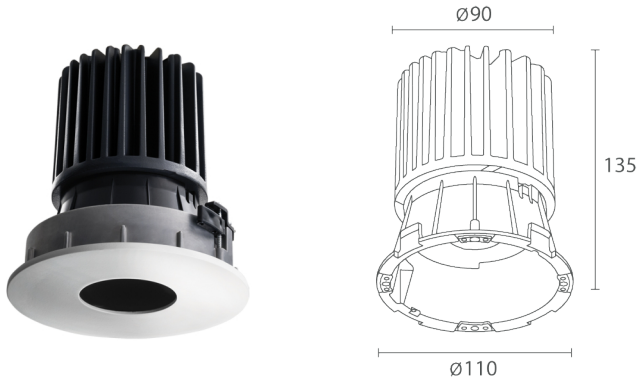

DESCRIPTION

recessed downlight for indoor applications; recessed (ceiling); Power consumption: max 15W; Power supply: max 400mA; Lumen output at source: 1349 lm (3000K, 400mA, CRI >90); Delivered lumen output: 1094 lm (3000K, 400mA, 36°, CRI >90); 1 power LED High Intensity, 2-step MacAdam, 50 000h L90 B10 (Ta 25°C); LED colour: 4000K; Optics: 36°: optical system consisting of a deep-set, high-efficiency TIR lens; CRI Colour Rendering Index: >90; Body material: body made of low-copper-content die-cast aluminium alloy EN AB 46100, for excellent corrosion resistance, and flame-retardant Bayblend. Trim and cover made of low-copper-content die-cast aluminium alloy EN AB 46100 for excellent resistance to corrosion; RAL finish on request; power supply unit not included; Wiring: series; includes 2x0.30 m single-core PVC cables; Control system: dimming via dimmable driver; Ingress protection: IP40, IP44 with filter; UGR <13 for versions with flat and shallow covers, UGR <19 for versions with deep cover; Easy to wire. The electrical cables can be attached directly to the connector, making the product easier to install; Casambi control using the Casambi app with dedicated electronics; Operating temperature: 0°C — +45°C; Appliance class: class III; Weight: 900 gr; Dimensions: ø136 mm / 136x136 mm; Energy efficiency class: F (light source) in accordance with EU 2019/2015; Accessories: WGCC30A1F Round bezel, WGCC30A1T Round bezel, WGCC30A2F Square bezel, WGCC30A2T Square bezel, WHCC30A1 Honeycomb louvre, WRCC30R1D Diffuser filter, WRCC30R1T Transparent IP44 screen, WRCC30R1W Elliptical filter, WZCC30108 Flat, round cover, WZCC3010E Flat, round cover, WZCC3010N Flat, round cover, WZCC3010Z Flat, round cover, WZCC30208 Flat, square cover, WZCC3020E Flat, square cover, WZCC3020N Flat, square cover, WZCC3020Z Flat, square cover, WZCC30308 Shallow, round cover, WZCC3030E Shallow, round cover, WZCC3030N Shallow, round cover, WZCC3030Z Shallow, round cover, WZCC30408 Shallow, square cover, WZCC3040E Shallow, square cover, WZCC3040N Shallow, square cover, WZCC3040Z Shallow, square cover, WZCC30508 Deep, round cover, WZCC3050E Deep, round cover, WZCC3050N Deep, round cover, WZCC3050Z Deep, round cover, WZCC30608 Deep, square cover, WZCC3060E Deep, square cover, WZCC3060N Deep, square cover, WZCC3060Z Deep, square cover; tested and approved via E.O.L. (End Of Line) test with functioning test and check of electrical power consumption

Status: Available

ELECTRICAL CHARACTERISTICS

Power consumption	max 15W
Power supply	max 400mA
Power supply unit	power supply unit not included
Control system	dimming via dimmable driver
Wiring	series

LIGHTING CHARACTERISTICS

Number and type of LED	1 power LED High Intensity
Average LED life	50 000h L90 B10 (Ta 25°C)
LED colour	4000K
CRI Colour Rendering Index	>90
Binning	2-step MacAdam
Optics	36°
Lumen output at source	1349 lm (3000K, 400mA, CRI >90)
Delivered lumen output	1094 lm (3000K, 400mA, 36°, CRI >90)

MECHANICAL CHARACTERISTICS

Dimensions	ø136 mm / 136x136 mm
Weight	900 gr
Body material	body in die-cast aluminium and Bayblend, bezel and cover in die-cast aluminium

GENERAL CHARACTERISTICS

Ingress protection	IP40, IP44 with filter
Operating temperature	0°C — +45°C
Features	UGR <13 for versions with flat and shallow covers, UGR <19 for versions with deep cover
Energy efficiency class	F (light source) in accordance with EU 2019/2015
Appliance class	class III
Walkover	no
Drive-over	no
Power cables	includes 2x0.30 m single-core PVC cables
Notes	Easy to wire. The electrical cables can be attached directly to the connector, making the product easier to install; Casambi control using the Casambi app with dedicated electronics

PHOTOMETRIC DATA

L - 36° CRI 90 flat, round cover

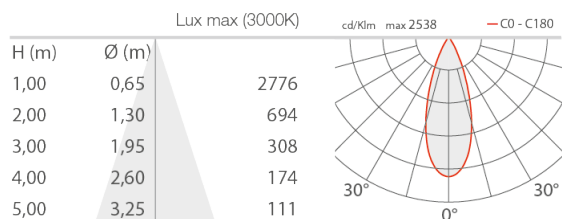

L - 36° CRI 90 flat, square cover

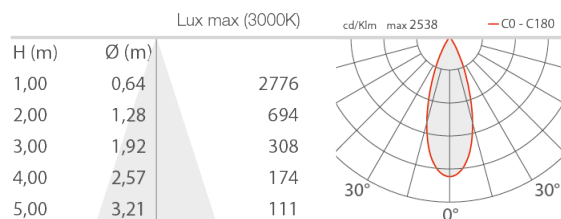

L - 36° CRI 90 shallow, round cover

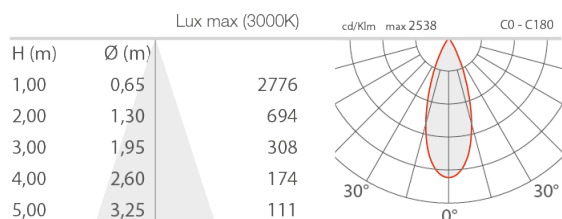

L - 36° CRI 90 shallow, square cover

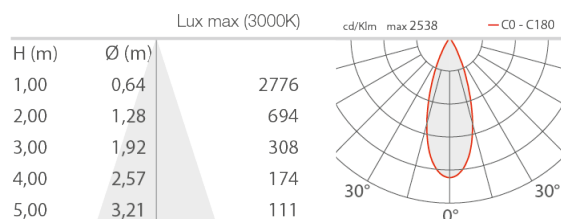

L - 36° CRI 90 deep, round cover

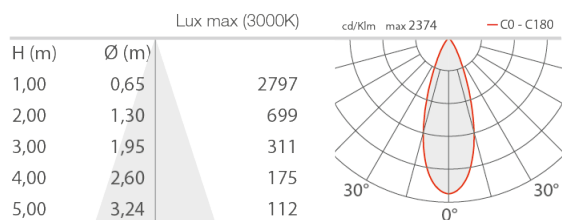

L - 36° CRI 90 deep, square cover

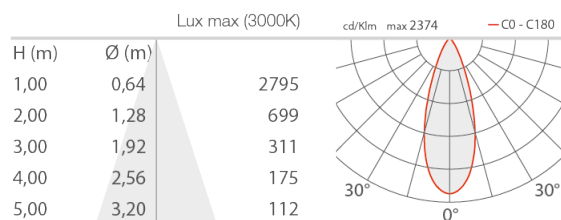

ACCESSORIES

Installation Accessories



WGCC30A1F

Round bezel

for installation flush with ceiling

Required installation accessories, not included



WGCC30A1T

Round bezel

for rebated installation

Required installation accessories, not included



WGCC30A2F

Square bezel

for installation flush with ceiling

Required installation accessories, not included

**WGCC30A2T**

Square bezel

for rebated installation

Required installation accessories, not included

**WZCC30108**

Flat, round cover

primer

The paints that can be used on primed lighting fixtures are the same ones that are suitable for use on masonry surfaces, i.e: two-pack polyurethane varnishes, two-pack acrylic paints

Required installation accessories, not included

**WZCC3010E**

Flat, round cover

white

Required installation accessories, not included

**WZCC3010N**

Flat, round cover

black

Required installation accessories, not included

**WZCC3010Z**

Flat, round cover

antique bronze

Required installation accessories, not included

**WZCC30208**

Flat, square cover

primer

The paints that can be used on primed lighting fixtures are the same ones that are suitable for use on masonry surfaces, i.e: two-pack polyurethane varnishes, two-pack acrylic paints

Required installation accessories, not included

**WZCC3020E**

Flat, square cover

white

Required installation accessories, not included

**WZCC3020N**

Flat, square cover

black

Required installation accessories, not included

**WZCC3020Z**

Flat, square cover

antique bronze

Required installation accessories, not included



**WZCC30308**

Shallow, round cover
primer

The paints that can be used on primed lighting fixtures are the same ones that are suitable for use on masonry surfaces, i.e: two-pack polyurethane varnishes, two-pack acrylic paints
Required installation accessories, not included

**WZCC3030E**

Shallow, round cover
white

Required installation accessories, not included

**WZCC3030N**

Shallow, round cover
black

Required installation accessories, not included

**WZCC3030Z**

Shallow, round cover
antique bronze

Required installation accessories, not included

**WZCC30408**

Shallow, square cover
primer

The paints that can be used on primed lighting fixtures are the same ones that are suitable for use on masonry surfaces, i.e: two-pack polyurethane varnishes, two-pack acrylic paints
Required installation accessories, not included

**WZCC3040E**

Shallow, square cover
white

Required installation accessories, not included

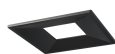
**WZCC3040N**

Shallow, square cover
black

Required installation accessories, not included

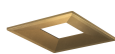
**WZCC3040Z**

Shallow, square cover
antique bronze

Required installation accessories, not included

**WZCC30508**

Deep, round cover
primer

**WZCC3050E**

Deep, round cover
white

The paints that can be used on primed lighting fixtures are the same ones that are suitable for use on masonry surfaces, i.e: two-pack polyurethane varnishes, two-pack acrylic paints
Required installation accessories, not included

Required installation accessories, not included



WZCC3050N

Deep, round cover
black

Required installation accessories, not included

WZCC3050Z

Deep, round cover
antique bronze

Required installation accessories, not included



WZCC30608

Deep, square cover
primer

The paints that can be used on primed lighting fixtures are the same ones that are suitable for use on masonry surfaces, i.e: two-pack polyurethane varnishes, two-pack acrylic paints
Required installation accessories, not included

WZCC3060E

Deep, square cover
white

Required installation accessories, not included



WZCC3060N

Deep, square cover
black

Required installation accessories, not included

WZCC3060Z

Deep, square cover
antique bronze

Required installation accessories, not included

Anti-glare

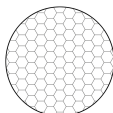

WHCC30A1

Honeycomb louvre
round and square covers: flat, shallow

Optical Accessories

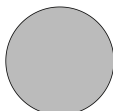

WRCC30R1D

Diffuser filter

round and square covers: flat, shallow

WRCC30R1W

Elliptical filter

Adding the filter changes the light output: please consult the photometric data.

round and square covers: flat, shallow

Other**WRCC30R1T**

Transparent IP44 screen

round and square covers: flat, shallow

L&L Luce&Light SRL reserves the right to change the information contained in this document at any time without prior notice being given.