

Made in Italy

 **Spot 1.0, code: CF10125MAI**  
Projectors for outdoor applications

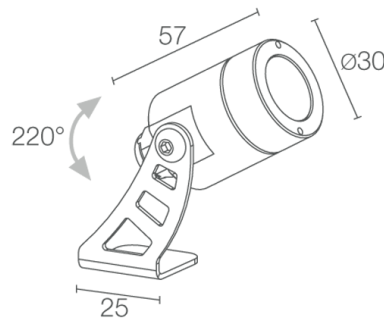

03/04/2025 Rev. 09/2024



## DESCRIPTION

projector for outdoor applications (not suitable for use in immersion in swimming pools or fountains); surface mounted (ceiling, wall, ground, spike, strap); Power consumption: max 2W; Power supply: max 500mA; Lumen output at source: 145 lm (3000K, 500mA); Delivered lumen output: 88 lm (3000K, 500mA, 20°); 1 power LED, 1/4 ANSI BIN, 50 000h L90 B10 (Ta 25°C); LED colour: 3000K; Optics: 20°; CRI Colour Rendering Index: 80; Body material: body and trim in AISI 316L stainless steel; RAL finish on request; Screen material: screen in tempered, transparent glass; power supply unit not included; Wiring: series; includes 1.5 m neoprene cable, H05RN-F 2x0,35/0,75 Ø6,3 mm; Control system: dimming via dimmable driver; Ingress protection: IP68; Impact resistance: IK10; version with elliptical optics available on request; Casambi control using the Casambi app with dedicated electronics; Protection systems: IPS (Intelligent Protection System) protects lighting fixtures from water infiltrations, which can occur if there are faulty junctions between the cables in outdoor or underwater applications. This innovation, patented by L&L, also guarantees electrical protection against polarity reversal, hot plugging, ESD and power surges, which can occur if there are faults in the electrical circuit; Operating temperature: -20°C — +45°C; Glow wire test: 960°C; Photobiological safety: photobiological safety: risk group 1 according to EN 62471:2006; Appliance class: class III; Weight: 400 g; Dimensions: Ø30x57mm; Energy efficiency class: F (light source) in accordance with EU 2019/2015; Accessories: WB0320I Standard snoot - stainless steel, WB0321I Asymmetrical snoot - stainless steel, WH0101 Honeycomb louvre, WP0100 Spike for in-ground installation, WP1004 Fastener strap - 5 m; tested and approved via E.O.L. (End Of Line) test with functioning test and check of electrical power consumption

Status: Available

### ELECTRICAL CHARACTERISTICS

Power consumption	max 2W
Power supply	max 500mA
Power supply unit	power supply unit not included
Control system	dimming via dimmable driver
Wiring	series

### LIGHTING CHARACTERISTICS

Number and type of LED	1 power LED
Average LED life	50 000h L90 B10 (Ta 25°C)
LED colour	3000K
CRI Colour Rendering Index	80
Binning	1/4 ANSI BIN
Optics	20°
Lumen output at source	145 lm (3000K, 500mA)
Delivered lumen output	88 lm (3000K, 500mA, 20°)

### MECHANICAL CHARACTERISTICS

Dimensions	Ø30x57mm
Weight	400 g
Mounting	with bracket and screws
Body material	body and trim in AISI 316L stainless steel
Screen material	screen in transparent, tempered glass

### GENERAL CHARACTERISTICS

Ingress protection	IP68
Operating temperature	-20°C — +45°C
Impact resistance	IK10
Energy efficiency class	F (light source) in accordance with EU 2019/2015
Glow wire test	960°C
Appliance class	class III
Walkover	no
Drive-over	no
Power cables	includes 1.5 m neoprene cable, H05RN-F 2x0,35/0,75 Ø6,3 mm
Protection systems	IPS (Intelligent Protection System)
Photobiological safety	photobiological safety: risk group 1 according to EN 62471:2006
Notes	version with elliptical optics available on request; Casambi control using the Casambi app with dedicated electronics

## PHOTOMETRIC DATA

M - 20°

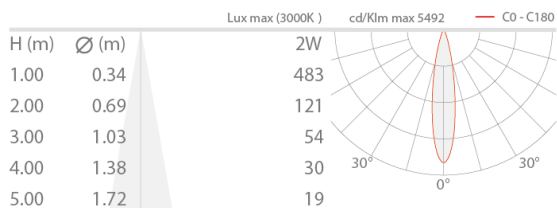

## ACCESSORIES

### Installation Accessories



WP0100

Spike for in-ground installation

### Anti-glare



WB0320I

Standard snoot - stainless steel



WB0321I

Asymmetrical snoot - stainless steel

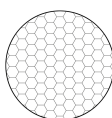

WH0101

Honeycomb louvre

built into the lighting fixture

The honeycomb louvre can be fitted on all fixed optics, except for sharp optics

Order together with the lighting fixture

### Other



WP1004

Fastener strap - 5 m

L&L Luce&Light SRL reserves the right to change the information contained in this document at any time without prior notice being given.