















Made in Italy

 **Beam 1.0, code: CD10116MAI**
Recessed for outdoor applications

23/11/2024 Rev. 42







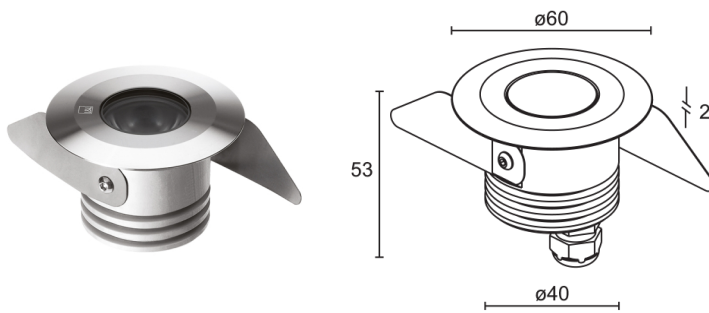

 kg 0,28
  Ø45 mm
 







DESCRIPTION

recessed for outdoor applications; walkover; recessed (ceiling, wall, floor); Power consumption: max 3W; Power supply: max 350mA; Lumen output at source: RGB: 217 lm, R: 80 lm G: 104 lm B: 33 lm (350mA); Delivered lumen output: RGB: 154 lm R: 57 lm G: 74 lm B: 23 lm (350mA, 19°); 1 full-colour LED, 50 000h L80 B10 (Ta 25°C); LED colour: RGB; Optics: 30°; Body material: body in anodized aluminium, trim in AISI 316L stainless steel; Finishes: stainless steel; RAL finish on request; Screen material: screen in transparent extra-clear glass; Thickness of installation surface: min 5 mm, max 30 mm; power supply unit not included; Wiring: series; includes 1.50 m FEP+RUB cable (equivalent to H05RN-F) 6x0.50/0.50 Ø6.3 mm; Control system: dimming via dimmable driver; Ingress protection: IP65, IP67; Impact resistance: IK08; version with 24Vdc power supply available on request; Casambi control using the Casambi app with dedicated electronics; Protection systems: IPS (Intelligent Protection System) protects lighting fixtures from water infiltrations, which can occur if there are faulty junctions between the cables in outdoor or underwater applications. This innovation, patented by L&L, also guarantees electrical protection against polarity reversal, hot plugging, ESD and power surges, which can occur if there are faults in the electrical circuit; Operating temperature: -20°C — +45°C; Maximum device temperature: 50°C (Ta 25°C); Glow wire test: 960°; Photobiological safety: photobiological safety: risk group 1 according to EN 62471:2006; Appliance class: class III; Weight: 280 g; Dimensions: Ø60x53 mm; Cutout dimensions: Ø45 mm; Volume of thermal heatsink: Ø80x100 mm; Energy efficiency class: F (light source) in accordance with EU 2019/2015; Accessories: WC1501 Outer casing; tested and approved via E.O.L. (End Of Line) test with functioning test and check of electrical power consumption

Status: Available

ELECTRICAL CHARACTERISTICS

Power consumption	max 3W
Power supply	max 350mA
Power supply unit	power supply unit not included
Control system	dimming via dimmable driver
Wiring	series

LIGHTING CHARACTERISTICS

Number and type of LED	1 full-colour LED
Average LED life	50 000h L80 B10 (Ta 25°C)
LED colour	RGB
Optics	30°
Lumen output at source	RGB: 217 lm, R: 80 lm G: 104 lm B: 33 lm (350mA)
Delivered lumen output	RGB: 154 lm R: 57 lm G: 74 lm B: 23 lm (350mA, 19°)

MECHANICAL CHARACTERISTICS

Dimensions	Ø60x53 mm
Weight	280 g
Finishes	stainless steel
Mounting	with fixing springs or outer casing
Body material	body in anodized aluminium, trim in AISI 316L stainless steel
Screen material	screen in transparent extra-clear glass
Cutout dimensions	Ø45 mm
Volume of thermal heatsink	Ø80x100 mm

GENERAL CHARACTERISTICS

Ingress protection	IP65, IP67
Operating temperature	-20°C — +45°C
Impact resistance	IK08
Energy efficiency class	F (light source) in accordance with EU 2019/2015
Glow wire test	960°
Maximum device temperature	50°C (Ta 25°C)
Appliance class	class III
Walkover	yes
Drive-over	no
Power cables	includes 1.50 m FEP+RUB cable (equivalent to H05RN-F) 6x0.50/0.50 Ø6.3 mm
Protection systems	IPS (Intelligent Protection System)
Photobiological safety	photobiological safety: risk group 1 according to EN 62471:2006
Notes	version with 24Vdc power supply available on request; Casambi control using the Casambi app with dedicated electronics

PHOTOMETRIC DATA

M - 30°

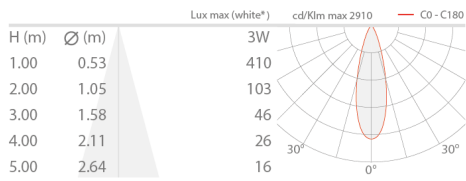

* White created by mixing the colours

ACCESSORIES

Installation Accessories



WC1501

Outer casing

L&L Luce&Light SRL reserves the right to change the information contained in this document at any time without prior notice being given.