

Made in Italy

 Cameo 2.6, code: CM2600100050SE
Recessed for indoor applications

01/04/2025 Rev. 09/2024

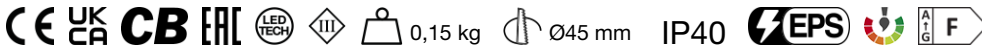

DESCRIPTION

recessed downlight for indoor applications; recessed (ceilings, false ceilings, niches in plasterboard); Power consumption: 5W; Power supply: 24Vdc; Lumen output at source: 452 lm (3000K); Delivered lumen output: 303 lm (3000K, 32°); 1 power LED High Intensity, 3-step MacAdam, 50 000h L95 B10 (Ta 25°C); LED colour: 3000K; Optics: 11°: optical system consisting of a high-efficiency TIR lens combined with a high-quality technical filter; CRI Colour Rendering Index: >90; Body material: radiator in black anodized aluminium acting as a cooling element. Body and recessing frame in aluminium, made entirely on a CNC lathe. Springs in C67 annealed spring steel; Finishes: body and frame painted white (RAL 9003); RAL finish on request; Thickness of installation surface: min 5 mm, max 30 mm; power supply unit not included; includes 1.5 m PVC cable FROR 2x0.35/0.35 Ø3.5 mm; Ingress protection: IP40; Casambi control using the Casambi app with dedicated electronics; Protection systems: EPS protects fixtures for indoor applications against electrical problems. This innovation, patented by L&L, guarantees electrical protection against polarity reversal, hot plugging and voltage spikes of up to 48Vdc, which can occur if there are faults in the electrical circuit; Operating temperature: 0°C – +45°C; Photobiological safety: photobiological safety: risk group 1 according to EN 62471:2006; Appliance class: class III; Weight: 150 g; Dimensions: ø49x43 mm; Cutout dimensions: Ø45 mm; Energy efficiency class: F (light source) in accordance with EU 2019/2015; tested and approved via E.O.L. (End Of Line) test with functioning test and check of electrical power consumption

Status: Available

ELECTRICAL CHARACTERISTICS

Power consumption	5W
Power supply	24Vdc
Power supply unit	power supply unit not included

LIGHTING CHARACTERISTICS

Number and type of LED	1 power LED High Intensity
Average LED life	50 000h L95 B10 (Ta 25°C)
LED colour	3000K
CRI Colour Rendering Index	>90
Binning	3-step MacAdam
Optics	11°
Lumen output at source	452 lm (3000K)
Delivered lumen output	303 lm (3000K, 32°)

MECHANICAL CHARACTERISTICS

Dimensions	ø49x43 mm
Weight	150 g
Finishes	white RAL 9003
Mounting	with fixing springs
Body material	body and trim in aluminium
Cutout dimensions	Ø45 mm

GENERAL CHARACTERISTICS

Ingress protection	IP40
Operating temperature	0°C — +45°C
Energy efficiency class	F (light source) in accordance with EU 2019/2015
Appliance class	class III
Walkover	no
Drive-over	no
Power cables	includes 1.5 m PVC cable FROR 2x0.35/0.35 Ø3.5 m
Protection systems	EPS (Electrical Protection System)
Photobiological safety	photobiological safety: risk group 1 according to EN 62471:2006
Notes	Casambi control using the Casambi app with dedicated electronics

PHOTOMETRIC DATA

S - 11°

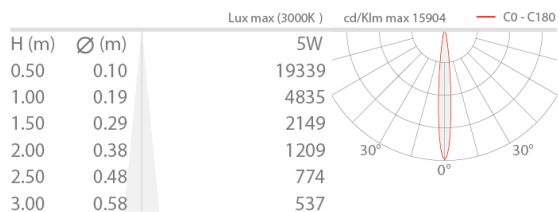

L&L Luce&Light SRL reserves the right to change the information contained in this document at any time without prior notice being given.