













Made in Italy

 Quad Maxi 1.1, code: MQ11105MBR
Recessed for indoor applications

21/11/2024 Rev. 34

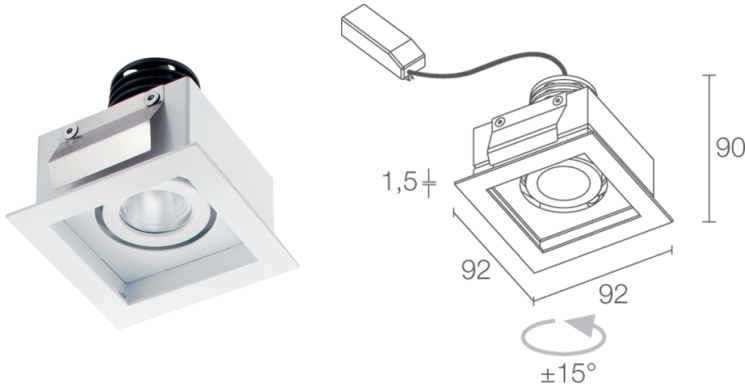

 on request
 

 kg 0,30
  75x75 mm
  IP40
  PUSH
  0/1-10V
 



DESCRIPTION

recessed downlight for indoor applications; recessed (ceiling); Power consumption: 8W; Power supply: 230Vac; Lumen output at source: 512 lm (3000K); Delivered lumen output: 425 lm (3000K, 29°); 1 multichip power LED, 2-step MacAdam, 50 000h L90 B10 (Ta 25°C); LED colour: 3000K; Optics: 29° tiltable $\pm 15^\circ$; CRI Colour Rendering Index: 80; Body material: body in anodized aluminium, trim in steel; Finishes: white (RAL 9003); RAL finish on request; Thickness of installation surface: min 5 mm, max 25 mm; power supply unit included; includes 0.30 m cable; Control system: 0/1-10V, PUSH; Ingress protection: IP40; Casambi-compatible version, controllable with the Casambi app, available on request; Operating temperature: 0°C — +45°C; Photobiological safety: photobiological safety: risk group 1 according to EN 62471:2006; Appliance class: class II; Weight: 300 g; Dimensions: 92x92x90 mm; Cutout dimensions: 75x75 mm; Volume of thermal heatsink: 175x175x150 mm; Energy efficiency class: F (light source) in accordance with EU 2019/2015; tested and approved via E.O.L. (End Of Line) test with functioning test and check of electrical power consumption

Status: Product being discontinued

ELECTRICAL CHARACTERISTICS

Power consumption	8W
Power supply	230Vac
Power supply unit	power supply unit included
Control system	0/1-10V, PUSH

LIGHTING CHARACTERISTICS

Number and type of LED	1 multichip power LED
Average LED life	50 000h L90 B10 (Ta 25°C)
LED colour	3000K
CRI Colour Rendering Index	80
Binning	2-step MacAdam
Optics	29° tiltable ±15°
Lumen output at source	512 lm (3000K)
Delivered lumen output	425 lm (3000K, 29°)

MECHANICAL CHARACTERISTICS

Dimensions	92x92x90 mm
Weight	300 g
Finishes	white RAL 9003
Mounting	with fixing springs
Body material	body in anodized aluminium, trim in steel
Cutout dimensions	75x75 mm
Volume of thermal heatsink	175x175x150 mm

GENERAL CHARACTERISTICS

Ingress protection	IP40
Operating temperature	0°C — +45°C
Energy efficiency class	F (light source) in accordance with EU 2019/2015
Appliance class	class II
Walkover	no
Drive-over	no
Power cables	includes 0.30 m cable
Photobiological safety	photobiological safety: risk group 1 according to EN 62471:2006
Notes	Casambi-compatible version, controllable with the Casambi app, available on request

PHOTOMETRIC DATA

M - 29°

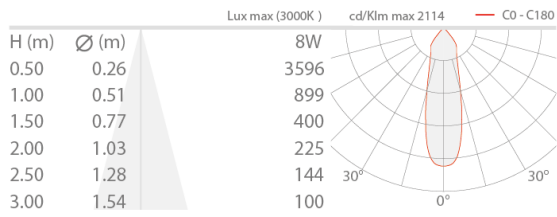

L&L Luce&Light SRL reserves the right to change the information contained in this document at any time without prior notice being given.