







Made in Italy

 Quad 6.1, code: QD61325LB
Recessed for indoor applications

21/11/2024 Rev. 31



 kg 0,30
  65x65 mm
  IP40
 

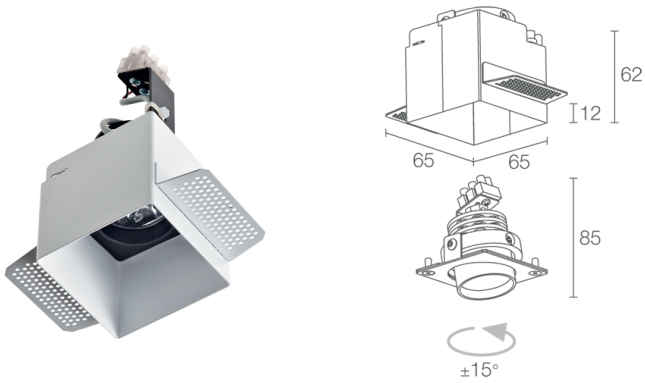

DESCRIPTION

recessed downlight for indoor applications; recessed (ceiling); Power consumption: max 6W; Power supply: max 500mA; Lumen output at source: 436 lm (3000K, 500mA); Delivered lumen output: 336 lm (3000K, 500mA, 24°); 3 power LEDs, 1/4 ANSI BIN, 50 000h L90 B10 (Ta 25°C); LED colour: 3000K; Optics: 56° tiltable $\pm 15^\circ$; CRI Colour Rendering Index: 80; Body material: body in anodized aluminium, trim in steel; Finishes: white (RAL 9003); RAL finish on request; Thickness of installation surface: min 5 mm, max 25 mm; power supply unit not included; Wiring: series; terminal block; Control system: dimming via dimmable driver; Ingress protection: IP40; Casambi-compatible version, controllable with the Casambi app, available on request; Operating temperature: 0°C — +45°C; Photobiological safety: photobiological safety: risk group 1 according to EN 62471:2006; Appliance class: class III; Weight: 300 g; Dimensions: 65x65x125 mm; Cutout dimensions: 65x65 mm; Volume of thermal heatsink: 165x165x150 mm; Energy efficiency class: F (light source) in accordance with EU 2019/2015; Accessories: WC2001 Outer casing for plasterboard; tested and approved via E.O.L. (End Of Line) test with functioning test and check of electrical power consumption

Status: Available

ELECTRICAL CHARACTERISTICS

Power consumption	max 6W
Power supply	max 500mA
Power supply unit	power supply unit not included
Control system	dimming via dimmable driver
Wiring	series

LIGHTING CHARACTERISTICS

Number and type of LED	3 power LEDs
Average LED life	50 000h L90 B10 (Ta 25°C)
LED colour	3000K
CRI Colour Rendering Index	80
Binning	1/4 ANSI BIN
Optics	56° tiltable ±15°
Lumen output at source	436 lm (3000K, 500mA)
Delivered lumen output	336 lm (3000K, 500mA, 24°)

MECHANICAL CHARACTERISTICS

Dimensions	65x65x125 mm
Weight	300 g
Finishes	white RAL 9003
Mounting	with fixing springs or outer casing
Body material	body in anodized aluminium, trim in steel
Cutout dimensions	65x65 mm
Volume of thermal heatsink	165x165x150 mm

GENERAL CHARACTERISTICS

Ingress protection	IP40
Operating temperature	0°C — +45°C
Energy efficiency class	F (light source) in accordance with EU 2019/2015
Appliance class	class III
Walkover	no
Drive-over	no
Power cables	terminal block
Photobiological safety	photobiological safety: risk group 1 according to EN 62471:2006
Notes	Casambi-compatible version, controllable with the Casambi app, available on request

PHOTOMETRIC DATA

L - 56°

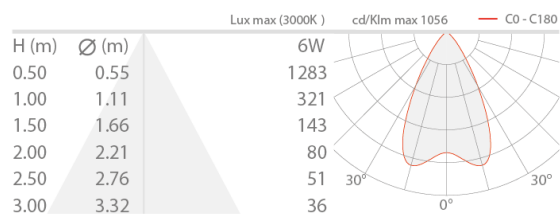

ACCESSORIES

Installation Accessories

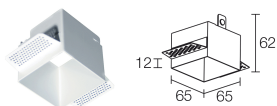

WC2001

Outer casing for plasterboard
Required outer casing not included

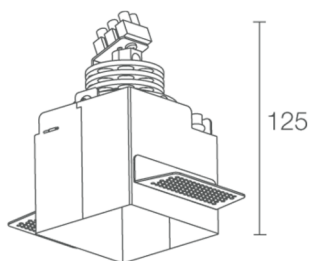

L&L Luce&Light SRL reserves the right to change the information contained in this document at any time without prior notice being given.