







Made in Italy

 Litus 5.6, code: LT560105MNV  
Recessed for outdoor applications

18/07/2024 Rev. 28

 kg 1000 - kN 10
  kg 0,70
  IP67 IK08
 

**CASAMBI**  

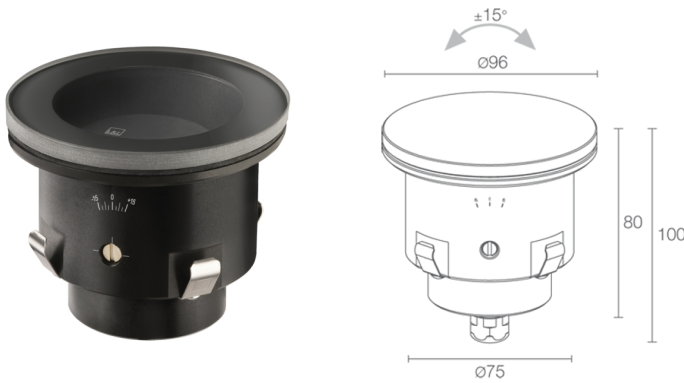

## DESCRIPTION

recessed for outdoor applications; drive-over up to 1000 kg; recessed (ceiling, wall, floor); Power consumption: 5W; Power supply: 24Vdc; Lumen output at source: 488 lm (3000K, 5W, CRI 80); Delivered lumen output: 352 lm (3000K, 34°, 5W, CRI 80); 1 high-intensity power LED, 3-step MacAdam, 50 000h L90 B10 (Ta 25°C); LED colour: 3000K; Optics: 34° tiltable ±15°: optical system consisting of a high-efficiency TIR lens; CRI Colour Rendering Index: 80; Body material: body made of ANTICORODAL 6082 aluminium alloy, made entirely on a CNC lathe and then electro-coloured black; Screen material: 6-mm-thick transparent extra-clear glass, high transmittance to ensure chromatic uniformity of light and tempered for excellent resistance to knocks and scratches, with a RAL 7015 signal grey serigraphed border; power supply unit not included; includes 1.5 m neoprene cable H05RN-F 2x0.75/0.75 Ø6.3 mm; Ingress protection: IP67; Impact resistance: IK08; version with 5° optics and 3.5W: 4000K only CRI 80, version with screen in serigraphed-white glass available on request; optical unit tiltable ±15° by turning the screw with the lever provided. Reference graduations pad printed on the fixture's body; Casambi control using the Casambi app with dedicated electronics; Protection systems: IPS (Intelligent Protection System) protects lighting fixtures from water infiltrations, which can occur if there are faulty junctions between the cables in outdoor or underwater applications. This innovation, patented by L&L, also guarantees electrical protection against polarity reversal, hot plugging, ESD and power surges, which can occur if there are faults in the electrical circuit; The PID (Protective Impedance Device) protects lighting fixtures from electrical phenomena external to the system, such as static electricity accumulation or electromagnetic interference coming from the mains power. Generally, these are events with a low energy content; Operating temperature: -20°C — +45°C; Maximum device temperature: 40°C (Ta 25°C); Glow wire test: 960°; Photobiological safety: photobiological safety: risk group 1 according to EN 62471:2006; Appliance class: class III; Weight: 700 g; Dimensions: Ø96x100 mm; Volume of thermal heatsink: Ø150x160 mm; Energy efficiency class: F (light source) in accordance with EU 2019/2015; Accessories: WC4050 Outer casing, WE0604S Anti-glare screen, half transparent and half serigraphed black, WH0205 Honeycomb louvre, WL0500 Suction cup; tested and approved via E.O.L. (End Of Line) test with functioning test and check of electrical power consumption

Status: Available

### ELECTRICAL CHARACTERISTICS

Power consumption	5W
Power supply	24Vdc
Power supply unit	power supply unit not included

### LIGHTING CHARACTERISTICS

Number and type of LED	1 high-intensity power LED
Average LED life	50 000h L90 B10 (Ta 25°C)
LED colour	3000K
CRI Colour Rendering Index	80
Binning	3-step MacAdam
Optics	34° tiltable ±15°
Lumen output at source	488 lm (3000K, 5W, CRI 80)
Delivered lumen output	352 lm (3000K, 34°, 5W, CRI 80)

### MECHANICAL CHARACTERISTICS

Dimensions	Ø96x100 mm
Weight	700 g
Mounting	with outer casing
Body material	body in black-anodized anticorrosional aluminium
Screen material	screen in serigraphed-grey and transparent, tempered extra-clear glass
Volume of thermal heatsink	Ø150x160 mm

### GENERAL CHARACTERISTICS

Ingress protection	IP67
Operating temperature	-20°C — +45°C
Impact resistance	IK08
Energy efficiency class	F (light source) in accordance with EU 2019/2015
Glow wire test	960°
Maximum device temperature	40°C (Ta 25°C)
Appliance class	class III
Walkover	yes
Drive-over	up to 1000 kg
Power cables	includes 1.5 m neoprene cable H05RN-F 2x0.75/0.75 Ø6.3 mm
Protection systems	IPS (Intelligent Protection System); PID (Protective Impedance Device)
Photobiological safety	photobiological safety: risk group 1 according to EN 62471:2006
Notes	version with 5° optics and 3.5W: 4000K only CRI 80, version with screen in serigraphed-white glass available on request; optical unit tiltable ±15° by turning the screw with the lever provided. Reference graduations pad printed on the fixture's body; Casambi control using the Casambi app with dedicated electronics

## PHOTOMETRIC DATA

M - 34° CRI 80

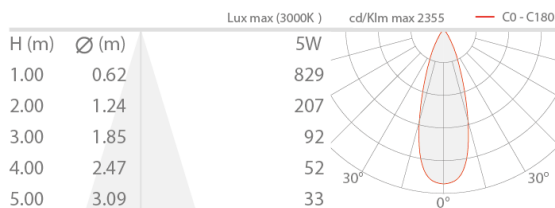

## ACCESSORIES

### Installation Accessories



**WC4050**  
Outer casing

### Anti-glare

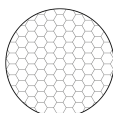

**WH0205**  
Honeycomb louvre  
built into the lighting fixture  
The honeycomb louvre can be fitted on all optics except for sharp optics;  
on 5° and 8° optics on request  
Order together with the lighting fixture

### Optical Accessories

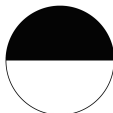

**WE0604S**  
Anti-glare screen, half transparent and half serigraphed black  
built into the lighting fixture  
Can be fitted on all optics except for RGB version  
Order together with the lighting fixture

### Other



**WL0500**  
Suction cup



Installation flush with ground

L&L Luce&Light SRL reserves the right to change the information contained in this document at any time without prior notice being given.