

Made in Italy

 **Ginko 3.0, code: GN300105WF**
Projectors for outdoor applications

17/07/2024 Rev. 44







 kg 1,25 - 2,41
 







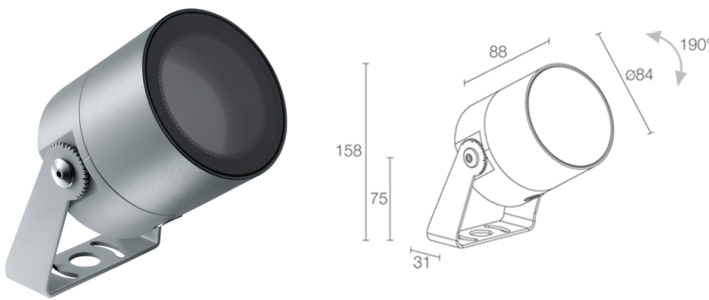

DESCRIPTION

projector for outdoor applications; surface mounted (ceiling, wall, ground, spike); Power consumption: 15W; Power supply: 24Vdc; Lumen output at source: 1662 lm (3000K, 15W, CRI 80); Delivered lumen output: 1162 lm (3000K, 42°, 15W, CRI 80); 1 high power density COB LED, 2-step MacAdam, 50 000h L95 B10 (Ta 25°C); LED colour: 3000K; Optics: adjustable 12°x64°: optical system consisting of a high-efficiency TIR lens combined with a high-quality elliptical technical filter and integrated with magnetic material for adjusting the ellipsis (patented); CRI Colour Rendering Index: 80; Body material: body made of ANTICORODAL 6082 low-copper-content aluminium alloy for excellent resistance to corrosion, made entirely on a CNC lathe. Bracket in AISI 316L stainless steel, tumble finished and painted; Finishes: grey finish obtained through an initial treatment with a ceramic nanoparticle coating, to prepare for painting, followed by a coat of epoxy paint and one of polyester paint to provide corrosion resistance of more than 1500 hours of salt spray. Paints compliant with the Qualicoat standard used in the automotive sector (RAL 9006); RAL finish on request; Screen material: 4-mm-thick transparent extra-clear glass, with high transmittance to ensure chromatic uniformity of light and tempered for excellent resistance to knocks and scratches, with RAL 7015 grey vitrified serigraphy around the edge; power supply unit not included; includes 1.5 m neoprene cable H05RN-F 2x0.75/0.75 Ø6.3 mm; Ingress protection: IP66, IP69; Impact resistance: IK09; 12°x64°, 28°x72° optics and shadow-effect filter, adjustable through 360° using the magnet provided; version with bracket in customized height available on request; version in brass available on request; Casambi control using the Casambi app with dedicated electronics; Protection systems: IPS (Intelligent Protection System) protects lighting fixtures from water infiltrations, which can occur if there are faulty junctions between the cables in outdoor or underwater applications. This innovation, patented by L&L, also guarantees electrical protection against polarity reversal, hot plugging, ESD and power surges, which can occur if there are faults in the electrical circuit; Operating temperature: -20°C — +45°C; Glow wire test: 960°; Photobiological safety: in accordance with IEC TR 62778:2014; Appliance class: class III; Weight: 1250 g, stainless steel: 2405 g; Dimensions: Ø84x88 mm; Energy efficiency class: F (light source) in accordance with EU 2019/2015; Accessories: WB8010F Standard snoot - grey, WB8010N Standard snoot - black anodized, WB8020F Asymmetrical snoot - grey, WE0201 Magnet for adjustable optics and zoom lens, WP0100 Spike for in-ground installation, WP1004 Fastener strap - 5 m, WP1006F Spike for in-ground installation - h 500 mm - grey, WP1007F Spike for in-ground installation - h 800 mm - grey; tested and approved via E.O.L. (End Of Line) test with functioning test and check of electrical power consumption

Status: Available

ELECTRICAL CHARACTERISTICS

Power consumption	15W
Power supply	24Vdc
Power supply unit	power supply unit not included

LIGHTING CHARACTERISTICS

Number and type of LED	1 high power density COB LED
Average LED life	50 000h L95 B10 (Ta 25°C)
LED colour	3000K
CRI Colour Rendering Index	80
Binning	2-step MacAdam
Optics	adjustable 12°x64°
Lumen output at source	1662 lm (3000K, 15W, CRI 80)
Delivered lumen output	1162 lm (3000K, 42°, 15W, CRI 80)

MECHANICAL CHARACTERISTICS

Dimensions	Ø84x88 mm
Weight	1250 g, stainless steel: 2405 g
Finishes	grey RAL 9006
Mounting	with bracket, screws and plugs
Body material	body in anticorodal aluminium, AISI 316L stainless steel bracket
Screen material	screen in serigraphed-grey and transparent, tempered extra-clear glass

GENERAL CHARACTERISTICS

Ingress protection	IP66, IP69
Operating temperature	-20°C — +45°C
Impact resistance	IK09
Features	12°x64°, 28°x72° optics and shadow-effect filter, adjustable through 360° using the magnet provided
Energy efficiency class	F (light source) in accordance with EU 2019/2015
Glow wire test	960°
Appliance class	class III
Walkover	no
Drive-over	no
Power cables	includes 1.5 m neoprene cable H05RN-F 2x0.75/0.75 Ø6.3 mm
Protection systems	IPS (Intelligent Protection System)
Photobiological safety	in accordance with IEC TR 62778:2014
Notes	version with bracket in customized height available on request; version in brass available on request; Casambi control using the Casambi app with dedicated electronics

PHOTOMETRIC DATA

W – 12°x64° CRI 80

H (m)	Ø (m)	Ø (m)	15W
1.00	0.20	1.25	3589
2.00	0.40	2.50	897
3.00	0.59	3.75	399
4.00	0.79	5.00	224
5.00	0.99	6.25	144

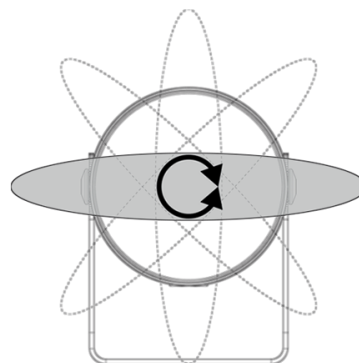
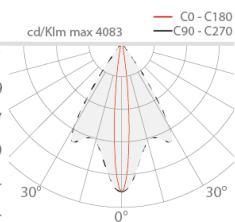

12°x64°

ACCESSORIES

Installation Accessories

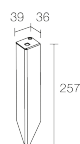

WP0100

Spike for in-ground installation

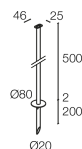

WP1006F

Spike for in-ground installation - h 500 mm - grey

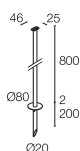

WP1007F

Spike for in-ground installation - h 800 mm - grey

Anti-glare



WB8010F

Standard snoot - grey



WB8010N

Standard snoot - black anodized

**WB8020F**

Asymmetrical snoot - grey

Other**WE0201**

Magnet for adjustable optics and zoom lens

**WP1004**

Fastener strap - 5 m

L&L Luce&Light SRL reserves the right to change the information contained in this document at any time without prior notice being given.