













Made in Italy

 Ginko 1.0, code: GN100005SI-1  
Projectors for outdoor applications

23/11/2024 Rev. 44





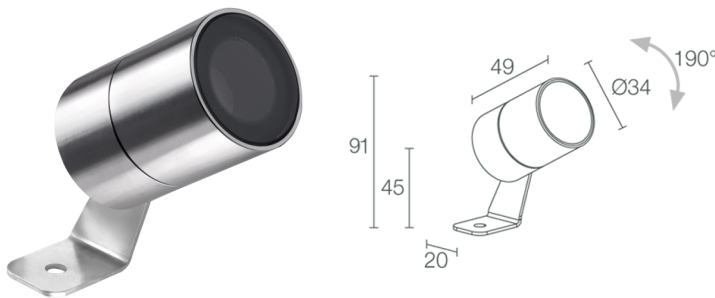

 kg 0,22 - 0,34 - 0,36
 





 CASAMBI 



## DESCRIPTION

projector for outdoor applications; surface mounted (ceiling, wall, ground, spike); Power consumption: 2,5W; Power supply: 24Vdc; Lumen output at source: 168 lm (3000K, 2.5W, CRI 80); Delivered lumen output: 146 lm (3000K, 2.5W, 19°, CRI 80); 1 power LED, 1/4 ANSI BIN, 50 000h L90 B10 (Ta 25°C); LED colour: 3000K; Optics: 19°: optical system consisting of a high-efficiency TIR lens combined with a high-quality technical filter; CRI Colour Rendering Index: 80; Body material: body and bracket made of AISI 316L stainless steel, made entirely on a CNC lathe and then tumble finished; Finishes: finish that provides corrosion resistance of more than 3000 hours of salt spray, making it possible to use the product even in extremely severe atmospheric conditions; RAL finish on request; Screen material: 4-mm-thick transparent extra-clear glass, with high transmittance to ensure chromatic uniformity of light and tempered for excellent resistance to knocks and scratches, with RAL 7015 grey vitrified serigraphy around the edge; power supply unit not included; includes 5 m neoprene cable H05RN-F 2x0.75/0.75 Ø6.3 mm; Ingress protection: IP66, IP69; Impact resistance: IK07; Casambi control using the Casambi app with dedicated electronics; Protection systems: IPS (Intelligent Protection System) protects lighting fixtures from water infiltrations, which can occur if there are faulty junctions between the cables in outdoor or underwater applications. This innovation, patented by L&L, also guarantees electrical protection against polarity reversal, hot plugging, ESD and power surges, which can occur if there are faults in the electrical circuit; The PID (Protective Impedance Device) protects lighting fixtures from electrical phenomena external to the system, such as static electricity accumulation or electromagnetic interference coming from the mains power. Generally, these are events with a low energy content; Operating temperature: -20°C — +45°C; Glow wire test: 960°; Photobiological safety: in accordance with IEC TR 62778:2014; Appliance class: class III; Weight: 220 g, stainless steel: 335 g, brass: 360 g; Dimensions: Ø34x49 mm; Energy efficiency class: F (light source) in accordance with EU 2019/2015; Accessories: WB8011N Standard snoot - black anodized, WB8021N Asymmetrical snoot - black anodized, WF3302 Flexible cable-protection tube - 18 cm, WH8001 Honeycomb louvre , WP0100 Spike for in-ground installation, WP1004 Fastener strap - 5 m; tested and approved via E.O.L. (End Of Line) test with functioning test and check of electrical power consumption

Status: Available

### ELECTRICAL CHARACTERISTICS

Power consumption	2,5W
Power supply	24Vdc
Power supply unit	power supply unit not included

### LIGHTING CHARACTERISTICS

Number and type of LED	1 power LED
Average LED life	50 000h L90 B10 (Ta 25°C)
LED colour	3000K
CRI Colour Rendering Index	80
Binning	1/4 ANSI BIN
Optics	19°
Lumen output at source	168 lm (3000K, 2.5W, CRI 80)
Delivered lumen output	146 lm (3000K, 2.5W, 19°, CRI 80)

### MECHANICAL CHARACTERISTICS

Dimensions	Ø34x49 mm
Weight	220 g, stainless steel: 335 g, brass: 360 g
Finishes	stainless steel
Mounting	with bracket, screws and plugs
Body material	body in AISI 316L stainless steel, AISI 316L stainless steel bracket
Screen material	screen in serigraphed-grey and transparent, tempered extra-clear glass

### GENERAL CHARACTERISTICS

Ingress protection	IP66, IP69
Operating temperature	-20°C — +45°C
Impact resistance	IK07
Energy efficiency class	F (light source) in accordance with EU 2019/2015
Glow wire test	960°
Appliance class	class III
Walkover	no
Drive-over	no
Power cables	includes 5 m neoprene cable H05RN-F 2x0.75/0.75 Ø6.3 mm
Protection systems	IPS (Intelligent Protection System); PID (Protective Impedance Device)
Photobiological safety	in accordance with IEC TR 62778:2014
Notes	Casambi control using the Casambi app with dedicated electronics

PHOTOMETRIC DATA

S - 19° CRI 80

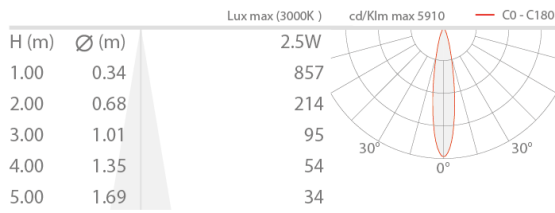

ACCESSORIES

Installation Accessories

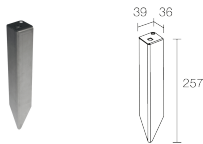

WP0100

Spike for in-ground installation

Anti-glare



WB8011N

Standard snoot - black anodized



WB8021N

Asymmetrical snoot - black anodized

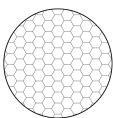

WH8001

Honeycomb louvre

built into the lighting fixture

The honeycomb louvre can be fitted on all optics, except for sharp optics

Order together with the lighting fixture

Other



**WF3302**

Flexible cable-protection tube - 18 cm  
Order together with the lighting fixture

**WP1004**

Fastener strap - 5 m

L&L Luce&Light SRL reserves the right to change the information contained in this document at any time without prior notice being given.