













Made in Italy

 **Bright 1.B, code: CB1B0105R6TI-1**
Step lights for outdoor applications

17/08/2024 Rev. 34

T max 50°C 

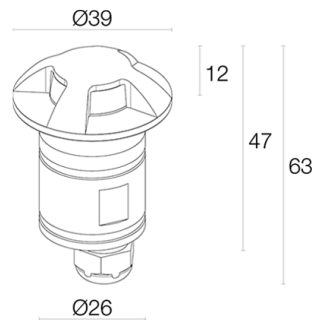

DESCRIPTION

step light for outdoor applications; walkover; recessed (wall, floor); Power consumption: 3,5W; Power supply: 24Vdc; Lumen output at source: 220 lm (3000K, 3.5W); Delivered lumen output: 56 lm (3000K, 4x60°, 3.5W); 1 power LED, 1/4 ANSI BIN, 50 000h L90 B10 (Ta 25°C); LED colour: 3000K; Optics: radial 1x180°: optical system, with silicone optics for durability, that in combination with the trim enables the creation of a single 180° light beam; Upward flux fraction: 32,83% (1x60°, 2x60°, 3x60°, 4x60°), 28,34% (1x120°), 30,63% (1x180°); CRI Colour Rendering Index: 80; Body material: body made of AISI 316L stainless steel, made on a CNC lathe. Head in AISI 316L stainless steel worked with tumbling and micro-shot peening, and then electropolished; Finishes: stainless steel; RAL finish on request; Seals: the silicone rubber gaskets guarantee maximum resistance to UV rays and unchanging mechanical characteristics over time; Thickness of installation surface: min 5 mm, max 30 mm; power supply unit not included; includes 5 m neoprene cable, H05RN-F 2x0,35/0,75 Ø6,3 mm; Ingress protection: IP65, IP68; Impact resistance: IK10; Casambi control using the Casambi app with dedicated electronics; Protection systems: IPS (Intelligent Protection System) protects lighting fixtures from water infiltrations, which can occur if there are faulty junctions between the cables in outdoor or underwater applications. This innovation, patented by L&L, also guarantees electrical protection against polarity reversal, hot plugging, ESD and power surges, which can occur if there are faults in the electrical circuit; Operating temperature: -20°C — +45°C; Maximum device temperature: 50°C (Ta 25°C); Glow wire test: 960°; Photobiological safety: in accordance with IEC TR 62778:2014; Appliance class: class III; Weight: 200 g; Dimensions: Ø39x63 mm; Cutout dimensions: Ø30 mm; Volume of thermal heatsink: Ø80x100 mm; Energy efficiency class: F (light source) in accordance with EU 2019/2015; Accessories: WC0202 Outer casing; tested and approved via E.O.L. (End Of Line) test with functioning test and check of electrical power consumption

Status: Available

ELECTRICAL CHARACTERISTICS

Power consumption	3,5W
Power supply	24Vdc
Power supply unit	power supply unit not included

LIGHTING CHARACTERISTICS

Number and type of LED	1 power LED
Average LED life	50 000h L90 B10 (Ta 25°C)
LED colour	3000K
CRI Colour Rendering Index	80
Binning	1/4 ANSI BIN
Optics	radial 1x180°
Lumen output at source	220 lm (3000K, 3.5W)
Delivered lumen output	56 lm (3000K, 4x60°, 3.5W)

MECHANICAL CHARACTERISTICS

Dimensions	Ø39x63 mm
Weight	200 g
Finishes	stainless steel
Mounting	with outer casing
Body material	body and trim in AISI 316L stainless steel
Cutout dimensions	Ø30 mm
Volume of thermal heatsink	Ø80x100 mm

GENERAL CHARACTERISTICS

Ingress protection	IP65, IP68
Operating temperature	-20°C — +45°C
Impact resistance	IK10
Energy efficiency class	F (light source) in accordance with EU 2019/2015
Glow wire test	960°
Maximum device temperature	50°C (Ta 25°C)
Appliance class	class III
Walkover	yes
Drive-over	no
Power cables	includes 5 m neoprene cable, H05RN-F 2x0,35/0,75 Ø6,3 mm
Protection systems	IPS (Intelligent Protection System)
Photobiological safety	in accordance with IEC TR 62778:2014
Notes	Casambi control using the Casambi app with dedicated electronics

PHOTOMETRIC DATA

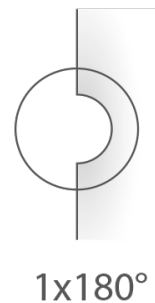
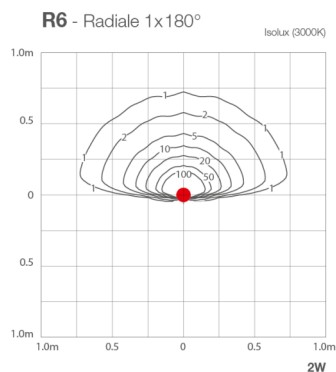

ACCESSORIES

Installation Accessories

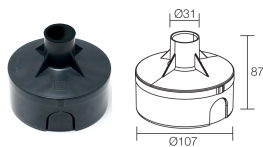

WC0202
Outer casing

L&L Luce&Light SRL reserves the right to change the information contained in this document at any time without prior notice being given.